

FEATURES

- 1.8/3.3 V Single Supply Operation
- Low power: 560 mW ($I_{OUTFS} = 20 \text{ mA}$; $f_{DAC} = 1 \text{ GSPS}$, 4 \times Interpolation)
- DNL = TBD LSB, INL = TBD LSB
- SFDR = TBD dBc to $f_{OUT} = 100 \text{ MHz}$
- ACLR = 78 dBc @ 80 MHz IF
- CMOS data interface with Autotracking Input Timing
- Analog Output: Adjustable 10-30mA ($R_L = 25 \Omega$ to 50Ω)
- 100-lead Exposed Paddle TQFP Package
- Multiple Chip Synchronization Interface
- 84dB Digital Interpolation Filter Stopband Attenuation
- Digital Inverse Sinc Filter

APPLICATIONS

- Wireless Infrastructure
 - Direct Conversion
 - Transmit Diversity
- Wideband Communications Systems:
 - Point-to-Point Wireless, LMDS

PRODUCT DESCRIPTION

The AD9776 is a dual 12-bit high performance, high frequency

FUNCTIONAL BLOCK DIAGRAM

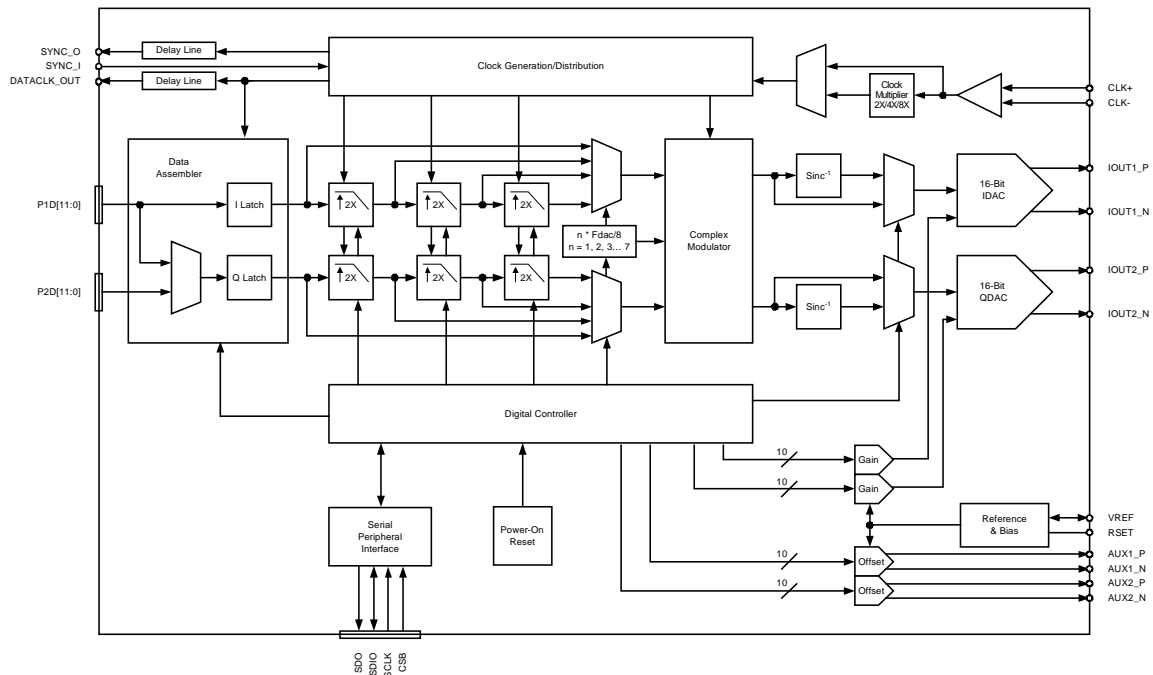

Figure 1 Functional Block Diagram

Rev. PrA

Information furnished by Analog Devices is believed to be accurate and reliable. However, no responsibility is assumed by Analog Devices for its use, nor for any infringements of patents or other rights of third parties that may result from its use. Specifications subject to change without notice. No license is granted by implication or otherwise under any patent or patent rights of Analog Devices. Trademarks and registered trademarks are the property of their respective owners.

DAC that provides a sample rate of 1 GSPS, permitting multi carrier generation up to its Nyquist frequency. It includes features optimized for direct conversion transmit applications, including complex digital modulation and gain and offset compensation. The DAC outputs are optimized to interface seamlessly with analog quadrature modulators such as the AD8349. A serial peripheral interface (SPI) provides for programming many internal parameters and also enables read-back of status registers. The output current can be programmed over a range of 10mA to 30mA. The AD9776 is manufactured on an advanced 0.18 μm CMOS process and operates from 1.8V and 3.3V supplies for a total power consumption of 325mW. It is supplied in a 100-lead QFP package.

PRODUCT HIGHLIGHTS

Ultra-low Noise and Intermodulation Distortion (IMD) enable high quality synthesis of wideband signals from baseband to high intermediate frequencies.

Single-ended CMOS interface supports a maximum input rate of 300 MSPS with 1x interpolation.

Manufactured on a CMOS process, the AD9776 uses a proprietary switching technique that enhances dynamic performance.

The current outputs of the AD9776 can be easily configured for various single-ended or differential circuit topologies.

TABLE OF CONTENTS

Specifications.....	3	Instruction Byte	12
DC SPECIFICATIONS	3	Serial Interface Port Pin Descriptions	12
DIGITAL SPECIFICATIONS.....	4	MSB/LSB Transfers	13
AC SPECIFICATIONS.....	4	Notes on Serial Port Operation	13
Pin Function Descriptions	5	SPI Register Map	14
Pin Configuration.....	6	Internal Reference/Full Scale Current Generation	22
Interpolation Filter Coefficients.....	7	Auxiliary DACs.....	22
INTERPOLATION Filter RESPONSE CURVES.....	8	Power Down and Sleep Modes	22
CHARACTERIZATION DATA	9	Internal PLL Clock Multiplier / Clock Distribution.....	23
General Description	12	Timing Information	23
Serial Peripheral Interface.....	12	Interpolation Filter Architecture.....	25
General Operation of the Serial Interface.....	12	EvaLUation Board Schematics.....	27

REVISION HISTORY

Revision PrA: Initial Version

SPECIFICATIONS¹

DC SPECIFICATIONS

(VDD33 = 3.3 V, VDD18 = 1.8 V, MAXIMUM SAMPLE RATE, UNLESS OTHERWISE NOTED)

	Parameter	Temp	Test Level	Min	Typ	Max	Unit
RESOLUTION					12		Bits
ACCURACY	Integral Nonlinearity (DNL)				TBD		LSB
	Differential Nonlinearity (INL)				TBD		LSB
ANALOG OUTPUTS	Offset Error				± TBD		% FSR
	Gain Error (With Internal Reference)				± TBD		% FSR
	Gain Error (Without Internal Reference)				± TBD		% FSR
	Full Scale Output Current			10	20	30	mA
	Output Compliance Range			1.0			V
	Output Resistance				TBD		kΩ
	Output Capacitance				TBD		pF
TEMPERATURE DRIFT	Offset				TBD		ppm/°C
	Gain				TBD		ppm/°C
	Reference Voltage				TBD		ppm/°C
REFERENCE	Internal Reference Voltage				1.2		V
	Output Current				100		nA
ANALOG SUPPLY VOLTAGES	VDDA33			3.13	3.3	3.47	V
	VDDA18			1.70	1.8	1.90	V
DIGITAL SUPPLY VOLTAGES	VDDD33			3.13	3.3	3.47	V
	VDDD18			1.70	1.8	1.90	V
	VDDCLK			1.70	1.8	1.90	V
POWER CONSUMPTION	600 MSPS				TBD		mW
	Standby Power				TBD		mW

Table 1: DC Specifications

¹ Specifications subject to change without notice

DIGITAL SPECIFICATIONS

(VDD33 = 3.3 V, VDD18 = 1.8 V, MAXIMUM SAMPLE RATE, UNLESS OTHERWISE NOTED)

Parameter		Temp	Test Level	Min	Typ	Max	Unit
DAC CLOCK INPUT (CLK+, CLK-)	Differential peak-to-peak Voltage				800		mV
	Common Mode Voltage				400		mV
	Maximum Clock Rate				1		GSPS
SERIAL PERIPHERAL INTERFACE	Maximum Clock Rate (SCLK)					40	MHz
	Maximum Pulse width high					TBD	ns
	Maximum pulse width low					TBD	ns

Table 2: Digital Specifications

AC SPECIFICATIONS

(VDD33 = 3.3 V, VDD18 = 1.8 V, MAXIMUM SAMPLE RATE, UNLESS OTHERWISE NOTED)

Parameter		Temp	Test Level	Min	Typ	Max	Unit
DYNAMIC PERFORMANCE	Output Settling Time (tst) (to 0.025%)				TBD		ns
	Output Rise Time (10% to 90%)				TBD		ns
	Output Fall Time (90% to 10%)				TBD		ns
	Output Noise (I _{OUT} FS=20mA)				TBD		pA/rHz
SPURIOUS FREE DYNAMIC RANGE (SFDR)	f _{DAC} = 100 MSPS, f _{OUT} = 20 MHz				73		dBc
	f _{DAC} = 200 MSPS, f _{OUT} = 50 MHz				73		dBc
	f _{DAC} = 400 MSPS, f _{OUT} = 70 MHz				75		dBc
	f _{DAC} = 800 MSPS, f _{OUT} = 70 MHz				78		dBc
TWO-TONE INTERMODULATION DISTORTION (IMD)	f _{DAC} = 200 MSPS, f _{OUT} = 50 MHz				82		dBc
	f _{DAC} = 400 MSPS, f _{OUT} = 60 MHz				79		dBc
	f _{DAC} = 400 MSPS, f _{OUT} = 80 MHz				72		dBc
	f _{DAC} = 800 MSPS, f _{OUT} = 100 MHz				79		dBc
NOISE SPECTRAL DENSITY (NSD)	f _{DAC} = 156 MSPS, f _{OUT} = 60 MHz				-149		dBm/Hz
	f _{DAC} = 200 MSPS, f _{OUT} = 80 MHz				-148		dBm/Hz
	f _{DAC} = 312 MSPS, f _{OUT} = 100 MHz				-150		dBm/Hz
	f _{DAC} = 400 MSPS, f _{OUT} = 100 MHz				-150		dBm/Hz
WCDMA ADJACENT CHANNEL LEAKAGE RATIO (ACLR), SINGLE CARRIER	f _{DAC} = 245.76 MSPS, f _{OUT} = 20 MHz				71		dBc
	f _{DAC} = 491.52 MSPS, f _{OUT} = 100 MHz				70		dBc
	f _{DAC} = 491.52 MSPS, f _{OUT} = 200 MHz				65		dBc
WCDMA SECOND ADJACENT CHANNEL LEAKAGE RATIO (ACLR), SINGLE CARRIER	f _{DAC} = 245.76 MSPS, f _{OUT} = 60 MHz				69		dBc
	f _{DAC} = 491.52 MSPS, f _{OUT} = 100 MHz				71		dBc
	f _{DAC} = 491.52 MSPS, f _{OUT} = 200 MHz				67		dBc

Table 3: AC Specifications

PIN FUNCTION DESCRIPTIONS

Pin No.	Name	Description	Pin No.	Name	Description
1	VDDC18	1.8 V Clock Supply	51	P2D<6>	Port 2 Data Input D6
2	VDDC18	1.8 V Clock Supply	52	P2D<5>	Port 2 Data Input D5
3	VSSC	Clock Common	53	VDDD18	1.8 V Digital Supply
4	VSSC	Clock Common	54	VSSD	Digital Common
5	CLK+	Differential Clock Input	55	P1D<4>	Port 2 Data Input D4
6	CLK-	Differential Clock Input	56	P1D<3>	Port 2 Data Input D3
7	VSSC	Clock Common	57	P1D<2>	Port 2 Data Input D2
8	VSSC	Clock Common	58	P1D<1>	Port 2 Data Input D1
9	VDDC18	1.8 V Clock Supply	59	P1D<0>	Port 2 Data Input D0 (LSB)
10	VDDC18	1.8 V Clock Supply	60	VDDD18	1.8 V Digital Supply
11	VSSC	Clock Common	61	VDDD33	3.3 V Digital Supply
12	VSSC	Clock Common	62	SYNC_O-	Differential Synchronization Output
13	SYNC_+	Differential Synchronization Input	63	SYNC_O+	Differential Synchronization Output
14	SYNC_-	Differential Synchronization Input	64	VSSD	Digital Common
15	VSSD	Digital Common	65	PLL_LOCK	PLL Lock Indicator
16	VDDD33	3.3 V Digital Supply	66	SPI_SDO	SPI Port Data Output
17	P1D<15>	Port 1 Data Input D15 (MSB)	67	SPI_SDIO	SPI Port Data Input/Output
18	P1D<14>	Port 1 Data Input D14	68	SPI_CLK	SPI Port Clock
19	P1D<13>	Port 1 Data Input D13	69	SPI_CSB	SPI Port Chip Select Bar
20	P1D<12>	Port 1 Data Input D12	70	RESET	Reset
21	P1D<11>	Port 1 Data Input D11	71	IRQ	Interrupt Request
22	VSSD	Digital Common	72	VSS	Analog Common
23	VDDD18	1.8 V Digital Supply	73	IPTAT	Reference Current
24	P1D<10>	Port 1 Data Input D10	74	VREF	Voltage Reference Output
25	P1D<9>	Port 1 Data Input D9	75	I120	120 μ A Reference Current
26	P1D<8>	Port 1 Data Input D8	76	VDDA33	3.3 V Analog Supply
27	P1D<7>	Port 1 Data Input D7	77	VSSA	Analog Common
28	P1D<6>	Port 1 Data Input D6	78	VDDA33	3.3 V Analog Supply
29	P1D<5>	Port 1 Data Input D5	79	VSSA	Analog Common
30	P1D<4>	Port 1 Data Input D4	80	VDDA33	3.3 V Analog Supply
31	P1D<3>	Port 1 Data Input D3	81	VSSA	Analog Common
32	VSSD	Digital Common	82	VSSA	Analog Common
33	VDDD18	1.8 V Digital Supply	83	IOUT2_P	Differential DAC Current Output, Channel 2
34	P1D<2>	Port 1 Data Input D2	84	IOUT2_N	Differential DAC Current Output, Channel 2
35	P1D<1>	Port 1 Data Input D1	85	VSSA	Analog Common
36	P1D<0>	Port 1 Data Input D0 (LSB)	86	AUX2_P	Auxiliary DAC Voltage Output, Channel 2
37	DATACLK_OUT	Data Clock Output	87	AUX2_N	Auxiliary DAC Voltage Output, Channel 2
38	VDDD33	3.3 V Digital Supply	88	VSSA	Analog Common
39	TXENABLE	Transmit Enable	89	AUX1_N	Auxiliary DAC Voltage Output, Channel 1
40	P2D<15>	Port 2 Data Input D15 (MSB)	90	AUX1_P	Auxiliary DAC Voltage Output, Channel 1
41	P2D<14>	Port 2 Data Input D14	91	VSSA	Analog Common
42	P2D<13>	Port 2 Data Input D13	92	IOUT1_N	Differential DAC Current Output, Channel 1
43	VDDD18	1.8 V Digital Supply	93	IOUT1_P	Differential DAC Current Output, Channel 1
44	VSSD	Digital Common	94	VSSA	Analog Common
45	P2D<12>	Port 2 Data Input D12	95	VSSA	Analog Common
46	P2D<11>	Port 2 Data Input D11	96	VDDA33	3.3 V Analog Supply
47	P2D<10>	Port 2 Data Input D10	97	VSSA	Analog Common
48	P2D<9>	Port 2 Data Input D9	98	VDDA33	3.3 V Analog Supply
49	P2D<8>	Port 2 Data Input D8	99	VSSA	Analog Common
50	P2D<7>	Port 2 Data Input D7	100	VDDA33	3.3 V Analog Supply

Table 4: Pin Function Descriptions

PIN CONFIGURATION

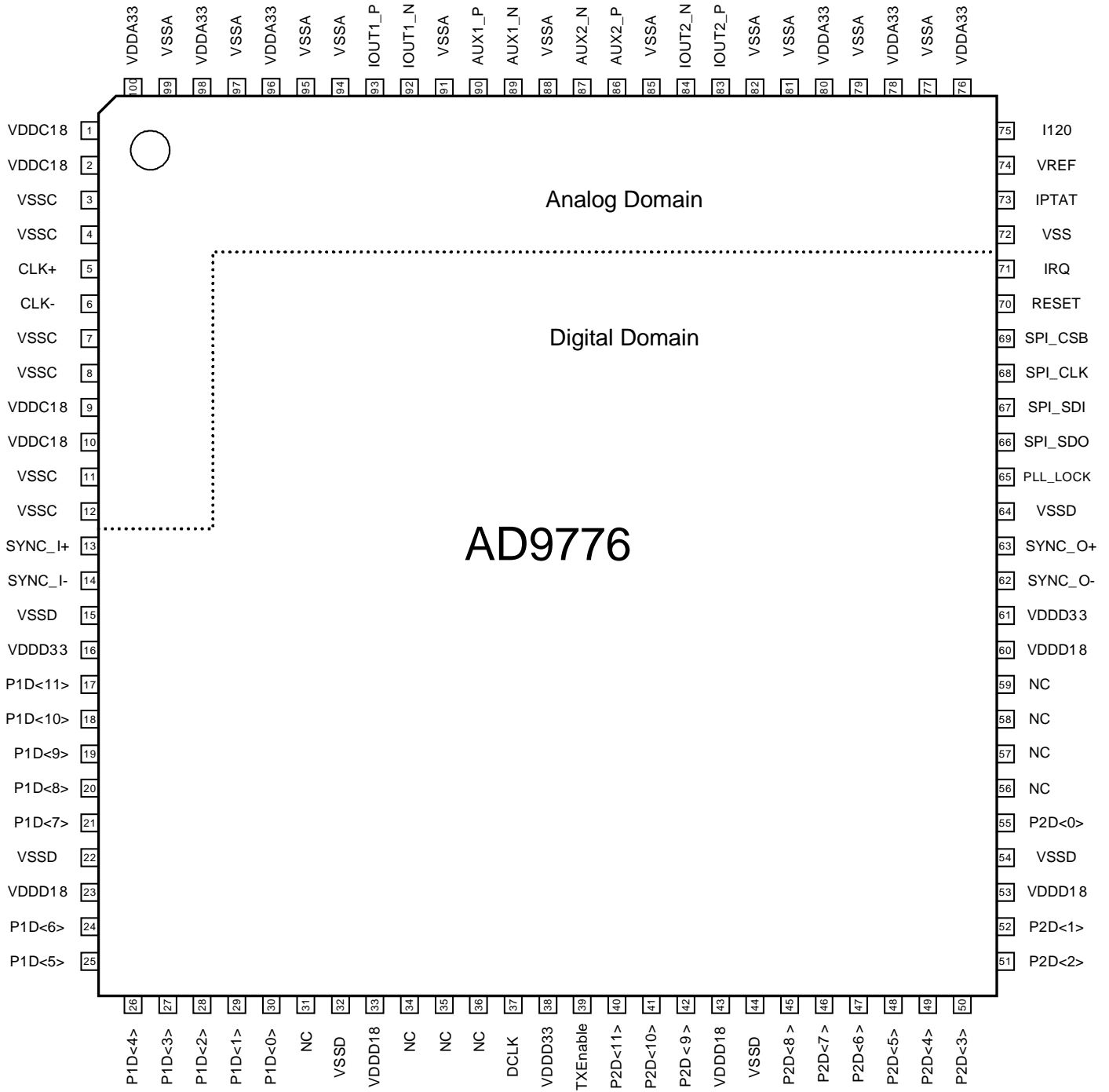

Figure 2. Pin Configuration

INTERPOLATION FILTER COEFFICIENTS

Table 5: Halfband Filter 1

Lower Coefficient	Upper Coefficient	Integer Value
H(1)	H(55)	-4
H(2)	H(54)	0
H(3)	H(53)	13
H(4)	H(52)	0
H(5)	H(51)	-34
H(6)	H(50)	0
H(7)	H(49)	72
H(8)	H(48)	0
H(9)	H(47)	-138
H(10)	H(46)	0
H(11)	H(45)	245
H(12)	H(44)	0
H(13)	H(43)	-408
H(14)	H(42)	0
H(15)	H(41)	650
H(16)	H(40)	0
H(17)	H(39)	-1003
H(18)	H(38)	0
H(19)	H(37)	1521
H(20)	H(36)	0
H(21)	H(35)	-2315
H(22)	H(34)	0
H(23)	H(33)	3671
H(24)	H(32)	0
H(25)	H(31)	-6642
H(26)	H(30)	0
H(27)	H(29)	20755
H(28)		32768

Table 6: Halfband Filter 2

Lower Coefficient	Upper Coefficient	Integer Value
H(1)	H(23)	-2
H(2)	H(22)	0
H(3)	H(21)	17
H(4)	H(20)	0
H(5)	H(19)	-75
H(6)	H(18)	0
H(7)	H(17)	238
H(8)	H(16)	0
H(9)	H(15)	-660
H(10)	H(14)	0
H(11)	H(13)	2530
H(12)		4096

Table 7: Halfband Filter 3

Lower Coefficient	Upper Coefficient	Integer Value
H(1)	H(15)	-39
H(2)	H(14)	0
H(3)	H(13)	273
H(4)	H(12)	0
H(5)	H(11)	-1102
H(6)	H(10)	0
H(7)	H(9)	4964
H(8)		8192

Table 8: Inverse Sinc Filter

Lower Coefficient	Upper Coefficient	Integer Value
H(1)	H(9)	2
H(2)	H(8)	-4
H(3)	H(7)	10
H(4)	H(6)	-35
H(5)		401

INTERPOLATION FILTER RESPONSE CURVES

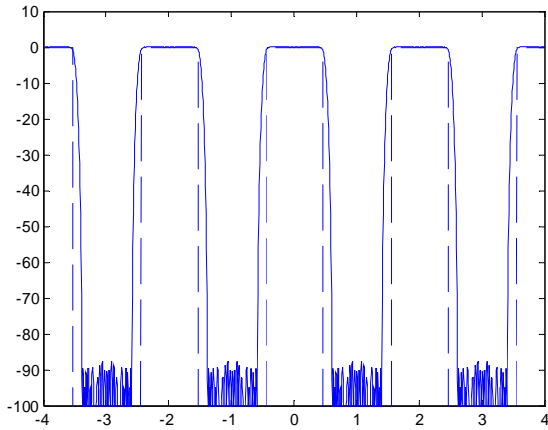

Figure 3. AD9776 2x Interpolation, Low Pass Response to $\pm 4x$ Input Data Rate (Dotted Lines Indicate 1dB Roll-Off)

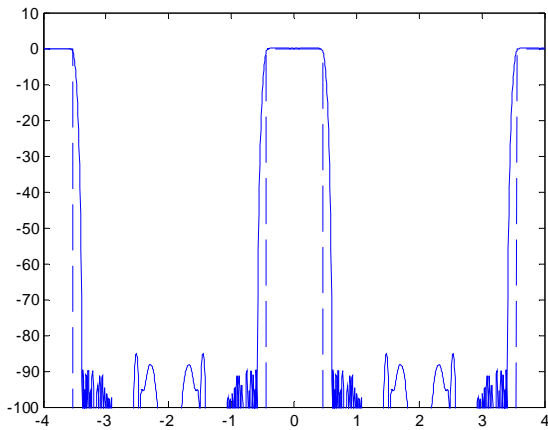

Figure 4. AD9776 4x Interpolation, Low Pass Response to $\pm 4x$ Input Data Rate (Dotted Lines Indicate 1dB Roll-Off)

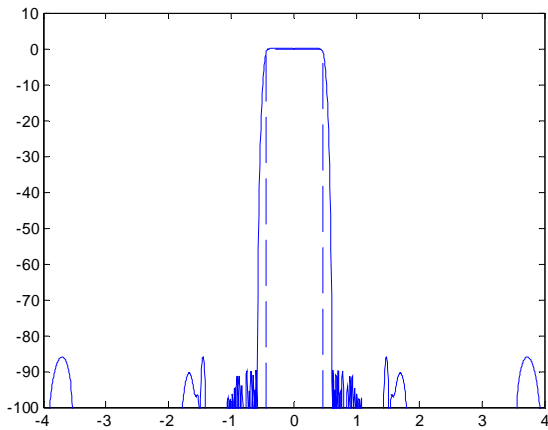

Figure 5. AD9776 8x Interpolation, Low Pass Response to $\pm 4x$ Input Data Rate (Dotted Lines Indicate 1dB Roll-Off)

CHARACTERIZATION DATA

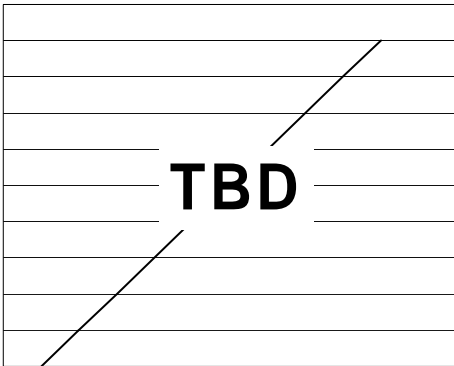

Figure 6. AD9776 Typical INL

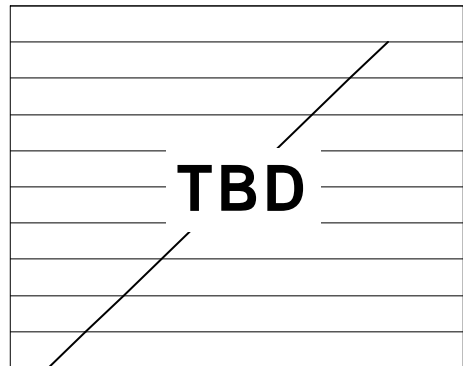

Figure 9. SFDR vs. F_{OUT} , 2x Interpolation

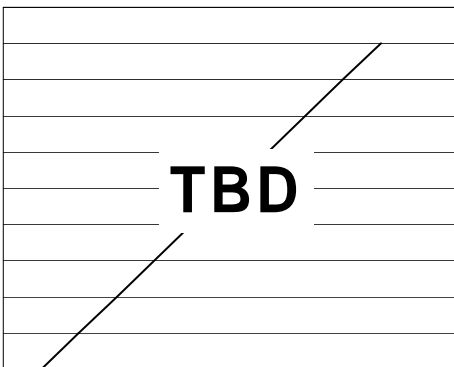

Figure 7. AD9776 Typical DNL

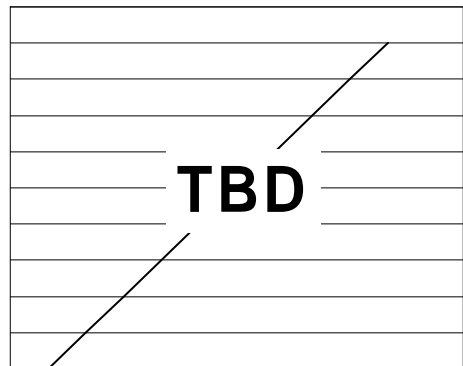

Figure 10. SFDR vs. F_{OUT} , 4x Interpolation

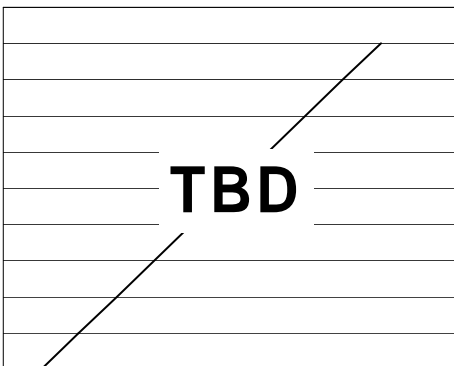

Figure 8. SFDR vs. F_{OUT} , 1x Interpolation

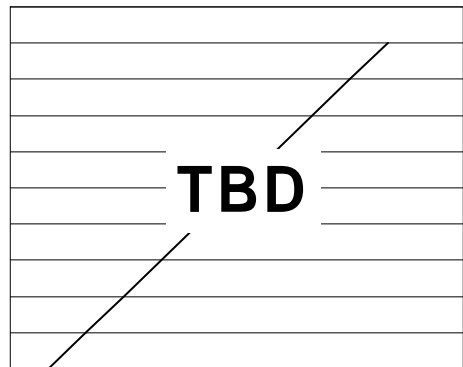

Figure 11. SFDR vs. F_{OUT} , 8x Interpolation

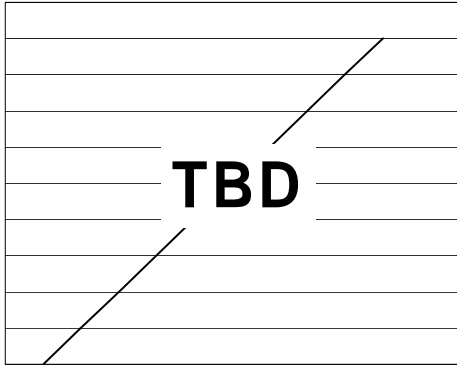

Figure 12. Third Order IMD vs. F_{OUT} , 1x Interpolation

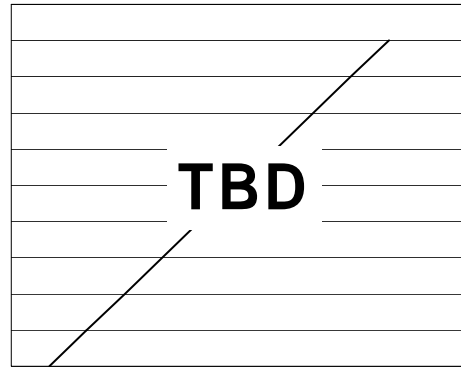

Figure 15. Third Order IMD vs. F_{OUT} , 8x Interpolation

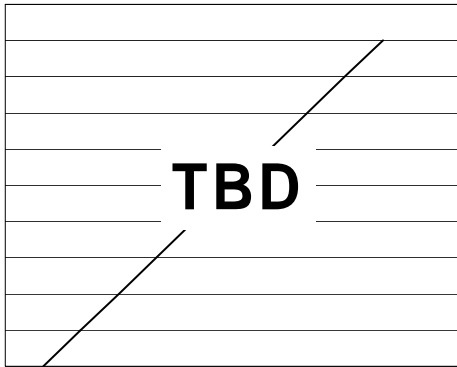

Figure 13. Third Order IMD vs. F_{OUT} , 2x Interpolation

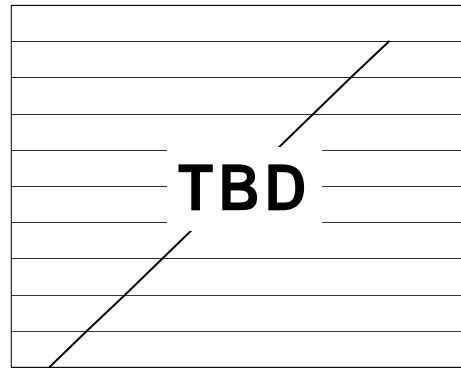

Figure 16. Noise Spectral Density vs. F_{OUT} , 1x Interpolation

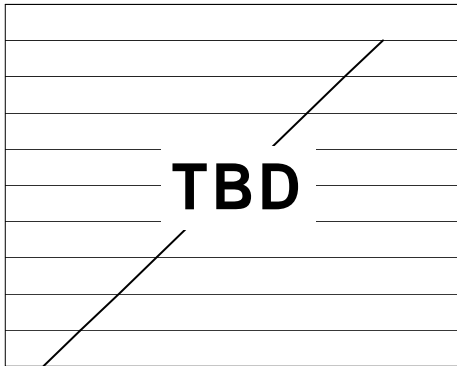

Figure 14. Third Order IMD vs. F_{OUT} , 4x Interpolation

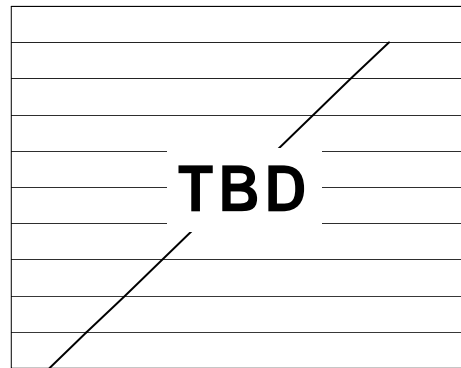

Figure 17. Noise Spectral Density vs. F_{OUT} , 2x Interpolation

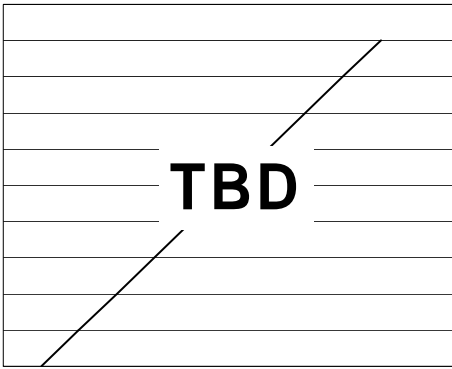

Figure 18. ACLR for 1st Adjacent Band WCDMA, 4x Interpolation. On-Chip Modulation is used to translate baseband signal to IF.

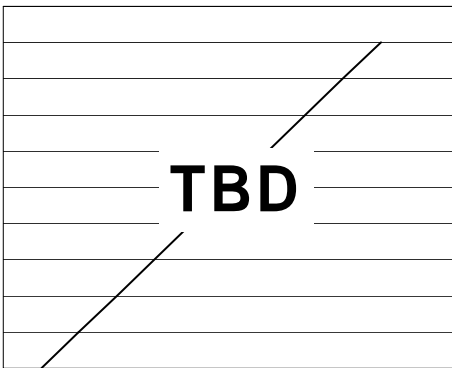

Figure 19. ACLR for 2nd Adjacent Band WCDMA, 4x Interpolation. On-Chip Modulation is used to translate baseband signal to IF.

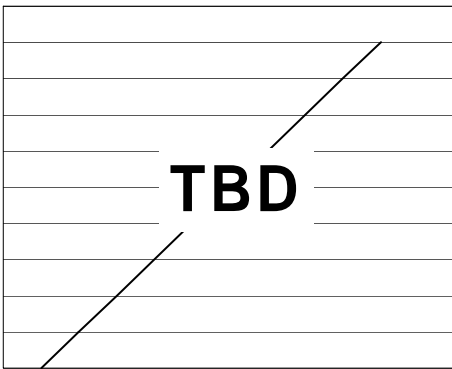

Figure 20. ACLR for 3rd Adjacent Band WCDMA, 4x Interpolation. On-Chip Modulation is used to translate baseband signal to IF.

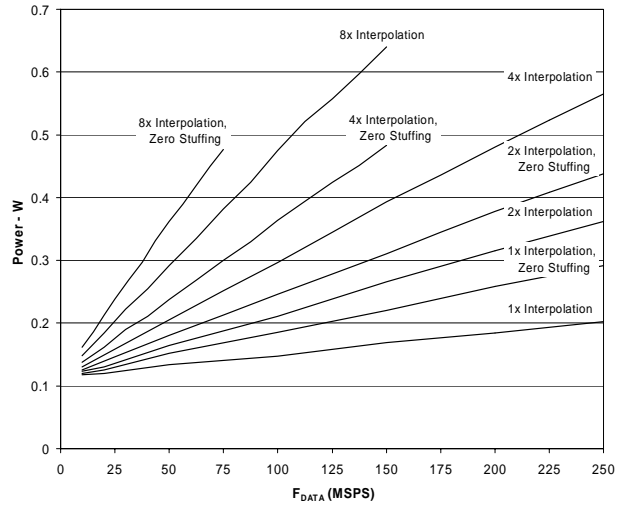

Figure 21. Power Dissipation, Single DAC Mode

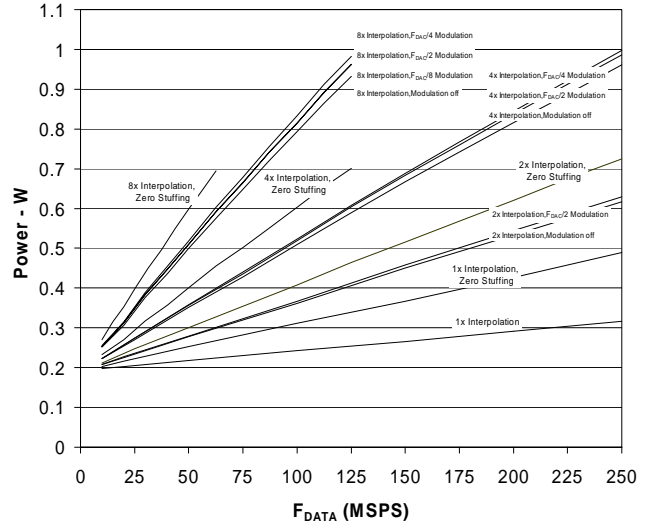

Figure 22. Power Dissipation, Dual DAC Mode

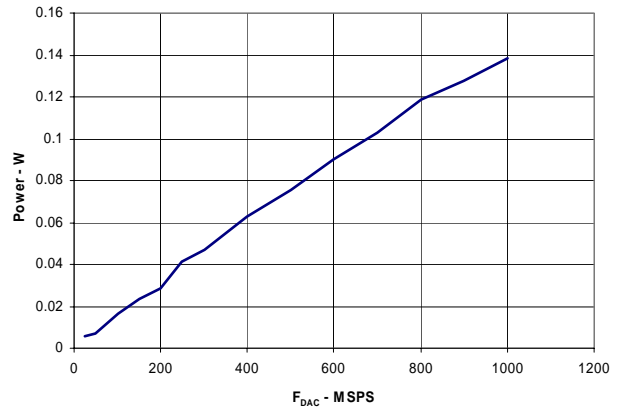

Figure 23. Power Dissipation of Inverse Sinc Filter

GENERAL DESCRIPTION

The AD9776 combines many features which make it a very attractive DAC for wired and wireless communications systems. The dual digital signal path and dual DAC structure allow an easy interface with common quadrature modulators when designing single sideband transmitters. The speed and performance of the AD9776 allow wider bandwidths/more carriers to be synthesized than with previously available DACs. The digital engine in the AD9776 uses a breakthrough filter architecture that combines the interpolation with a digital quadrature modulator. This allows the AD9776 to do digital quadrature frequency up conversion. The AD9776 also has features which allow simplified synchronization with incoming data, and also allows multiple AD9776s to be synchronized.

Serial Peripheral Interface

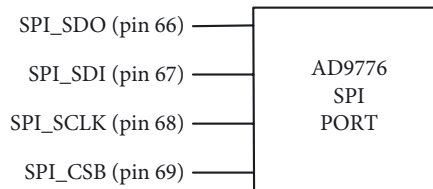

Figure 24. AD9776 SPI Port

The AD9776 serial port is a flexible, synchronous serial communications port allowing easy interface to many industry-standard microcontrollers and microprocessors. The serial I/O is compatible with most synchronous transfer formats, including both the Motorola SPI® and Intel® SSR protocols. The interface allows read/write access to all registers that configure the AD9776. Single or multiple byte transfers are supported, as well as MSB first or LSB first transfer formats. The AD9776's serial interface port can be configured as a single pin I/O (SDIO) or two unidirectional pins for in/out (SDIO/SDO).

General Operation of the Serial Interface

There are two phases to a communication cycle with the AD9776. Phase 1 is the instruction cycle, which is the writing of an instruction byte into the AD9776, coincident with the first eight SCLK rising edges. The instruction byte provides the AD9776 serial port controller with information regarding the data transfer cycle, which is Phase 2 of the communication cycle. The Phase 1 instruction byte defines whether the upcoming data transfer is read or write, the number of bytes in the data transfer, and the starting register address for the first byte of the data transfer. The first eight SCLK rising edges of each communication cycle are used to write the instruction byte into the AD9776.

A logic high on the CS pin, followed by a logic low, will reset the SPI port timing to the initial state of the instruction cycle. This is true regardless of the present state of the internal registers or the other signal levels present at the inputs to the SPI port. If the SPI port is in the midst of an instruction cycle or a data transfer cycle, none of the present data will be written.

The remaining SCLK edges are for Phase 2 of the communication cycle. Phase 2 is the actual data transfer between the AD9776 and the system controller. Phase 2 of the communication cycle is a transfer of 1, 2, 3, or 4 data bytes as determined by the instruction byte. Using one multibyte transfer is the preferred method. Single byte data transfers are useful to reduce CPU overhead when register access requires one byte only. Registers change immediately upon writing to the last bit of each transfer byte.

Instruction Byte

The instruction byte contains the information shown in **Error!**
Reference source not found..

MSB						LSB	
I7	I6	I5	I4	I3	I2	I1	I0
R/W	N1	N0	A4	A3	A2	A1	A0

Table 9. SPI Instruction Byte

R/W, Bit 7 of the instruction byte, determines whether a read or a write data transfer will occur after the instruction byte write. Logic high indicates read operation. Logic 0 indicates a write operation. **N1**, **N0**, Bits 6 and 5 of the instruction byte, determine the number of bytes to be transferred during the data transfer cycle. The bit decodes are shown in Table 10.

A4, **A3**, **A2**, **A1**, **A0**, Bits 4, 3, 2, 1, 0 of the instruction byte, determine which register is accessed during the data transfer portion of the communications cycle. For multibyte transfers, this address is the starting byte address. The remaining register addresses are generated by the AD9776 based on the LSBFIRST bit (REG00, bit 6).

N1	N2	Description
0	0	Transfer 1 Byte
0	1	Transfer 2 Bytes
1	0	Transfer 3 Bytes
1	1	Transfer 4 Bytes

Table 10. Byte Transfer Count

Serial Interface Port Pin Descriptions

SCLK—Serial Clock. The serial clock pin is used to synchronize data to and from the AD9776 and to run the internal state machines. SCLK's maximum frequency is 20 MHz. All data input to the AD9776 is registered on the rising edge of SCLK. All data is driven out of the AD9776 on the falling edge of SCLK.

CSB—Chip Select. Active low input starts and gates a communication cycle. It allows more than one device to be used on the same serial communications lines. The SDO and SDIO pins will go to a high impedance state when this input is high. Chip select should stay low during the entire communication cycle.

SDIO—Serial Data I/O. Data is always written into the AD9776 on this pin. However, this pin can be used as a bidirectional data line. The configuration of this pin is controlled by Bit 7 of register address 00h. The default is Logic 0, which configures the SDIO pin as unidirectional.

SDO—Serial Data Out. Data is read from this pin for protocols that use separate lines for transmitting and receiving data. In the case where the AD9776 operates in a single bidirectional I/O mode, this pin does not output data and is set to a high impedance state.

MSB/LSB Transfers

The AD9776 serial port can support both most significant bit (MSB) first or least significant bit (LSB) first data formats. This functionality is controlled by register bit LSBFIRST (REG00, bit 6). The default is MSB first (LSBFIRST = 0).

When LSBFIRST = 0 (MSB first) the instruction and data bytes must be written from most significant bit to least significant bit. Multibyte data transfers in MSB first format start with an instruction byte that includes the register address of the most significant data byte. Subsequent data bytes should follow in order from high address to low address. In MSB first mode, the serial port internal byte address generator decrements for each data byte of the multibyte communication cycle.

When LSBFIRST = 1 (LSB first) the instruction and data bytes must be written from least significant bit to most significant bit. Multibyte data transfers in LSB first format start with an instruction byte that includes the register address of the least significant data byte followed by multiple data bytes. The serial port internal byte address generator increments for each byte of the multibyte communication cycle.

The AD9776 serial port controller data address will decrement from the data address written toward 0x00 for multibyte I/O operations if the MSB first mode is active. The serial port controller address will increment from the data address written toward 0x1F for multibyte I/O operations if the LSB first mode is active.

Notes on Serial Port Operation

The AD9776 serial port configuration is controlled by REG00, bits 6 and 7. It is important to note that the configuration changes immediately upon writing to the last bit of the register. For multibyte transfers, writing to this register may occur during the middle of communication cycle. Care must be taken to compensate for this new configuration for the remaining bytes of the current communication cycle.

The same considerations apply to setting the software reset, RESET (REG00, bit 5). All registers are set to their default values EXCEPT REG00 and REG04 which remain unchanged.

Use of only single byte transfers when changing serial port

configurations or initiating a software reset is recommended to prevent unexpected device behavior.

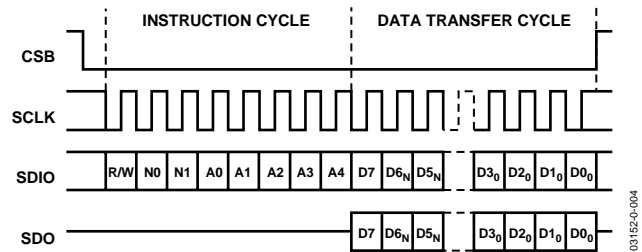

Figure 25. Serial Register Interface Timing MSB First

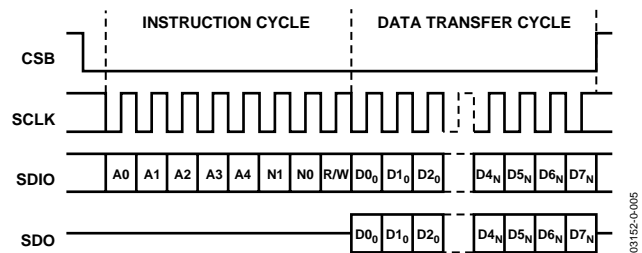

Figure 26. Serial Register Interface Timing LSB First

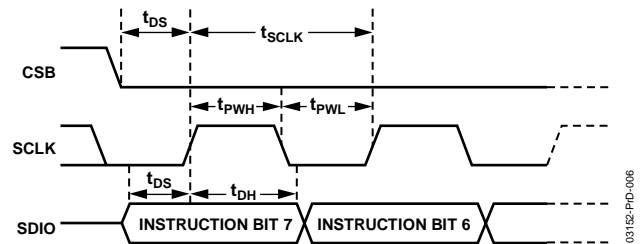

Figure 27. Timing Diagram for SPI Register Write

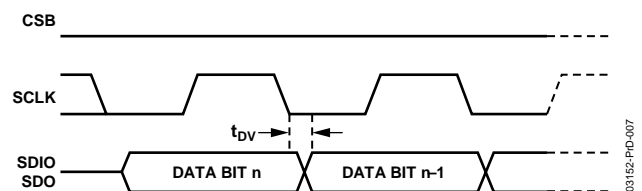

Figure 28. Timing Diagram for SPI Register Read

SPI Register Map

Register Name	Address		Bit 7	Bit 6	Bit 5	Bit 4	Bit 3	Bit 2	Bit 1	Bit 0	Default
Comm Register	00h	00	SDIO Bidirectional	LSB,MSB First	Software Reset	Power Down Mode	Auto Power Down Enable		PLL Lock Indicator		00h
Digital Control Register	01h	01	Filter Interpolation Factor <1:0>		Filter Interpolation Mode <4:0>					Zero Stuffing Enable	00h
	02h	02	Data Format	One Port Mode	Real Mode		Inverse Sinc Enable	DATACLK Invert	IQ Select Invert	Q First	00h
Sync Control	03h	03	Data Delay Mode <1:0>		Data Clock Delay <2:0>		Data Window Delay <2:0>			00h	
	04h	04	Sync Out Delay <3:0>				Sync Window Delay <3:0>				00h
	05h	05	Sync Enable	Sync Driver Enable	Dac Clock Offset <2:0>						00h
Interrupt Register	06h	06	Data Delay IRQ	Sync Delay IRQ	Cross Control IRQ		Data Delay IRQ Enable	Sync Delay IRQ Enable	Cross Control IRQ Enable		00h
PLL Control	07h	07	PLL Band Select <4:0>				PLL Loop Cap Select <2:0>				CFh
	08h	08	PLL Enable	PLL Output Freq Divide <1:0>		PLL Loop Freq Divide <1:0>		PLL Loop Filter Pole/Zero <2:0>			37h
Misc. Control Register	09h	24	PLL Error Source	PLL Ref Bypass	PLL Gain <2:0>			PLL Bias <2:0>			38h
IDAC Control Register	0Ah	09	IDAC Gain Adjustment <7:0>								F9h
	0Bh	10	IDAC SLEEP	IDAC Power Down				IDAC Gain Adjustment <9:8>			01h
Aux 1 DAC Control Register	0Ch	11	Auxiliary DAC1 Data <7:0>								00h
	0Dh	12	Auxiliary DAC1 Sign	Auxiliary DAC1 Current Direction	Auxiliary DAC1 Sleep		Auxiliary DAC1 Data <9:8>			00h	
QDAC Control Register	0Eh	13	QDAC Gain Adjustment <7:0>								F9h
	0Fh	14	QDAC SLEEP	QDAC Sleep				QDAC Gain Adjustment <9:8>			01h

Aux 2 DAC Control Register	10h	15	Auxiliary DAC2 Data <7:0>					00h
	11h	16	Auxiliary DAC2 Sign	Auxiliary DAC2 Current Direction	Auxiliary DAC2 Power Down		Auxiliary DAC2 Data <9:8>	00h
Cross Register	12h	17	Cross Updel <7:0>					00h
	13h	18	Cross Dndel <7:0>					00h
	14h	19	Cross Clock Divide <3:0>			Cross Wiggle Delay <3:0>		00h
	15h	20	Cross Run	Cross Status	Cross Done	Cross Wiggle <2:0>	Cross Step <1:0>	00h
Analog Write	16h	23	Analog Write <7:0>					00h
Analog Control Register	17h	21	Mirror Roll Off <1:0>			Band Gap Trim <2:0>	00h	
	18h	22	Stack Headroom Control<7:0>					CAh
Analog Status Register	19h	25	Analog Status <7:0>					--h
Test 1 Register	1Ah	26	MISR Enable	MISR IQ Select	MISR Samples	Internal Data Enable	Test Mode <2:0>	00h
Test 2 Register	18h	27	BIST<31:24>					--h
	1Ch	28	BIST<23:16>					--h
	1Dh	29	BIST<15:8>					--h
	1Eh	30	BIST<7:0>					--h

Table 11: SPI Register Map

Register (hex)	Bits	Name	Function	Default
00 Comm Register	7	SDIO Bidirectional	0: Use SDIO pin as input data only 1: Use SDIO as both input and output data	0
	6	LSB/MSB First	0: First bit of serial data is MSB of data byte 1: First bit of serial data is LSB of data byte	0
	5	Software RESET	Bit must be written with a 1, then 0 to soft reset SPI register map	0
	4	Power Down Mode	0: All circuitry is active 1: Disable all digital and analog circuitry, only SPI port is active	0
	3	Auto Power Down Enable		0
	1	PLL LOCK (read only)	0: PLL is not locked 1: PLL is locked	0
01 Digital Path Filter Control	7:6	Filter Interpolation Rate	00: 1x interpolation 01: 2x interpolation 10: 4x interpolation 11: 8x interpolation	00
	5:2	Control Halfband Filters 1,2,3	See Table 13 for filter modes	0000
	0	Zero Stuffing	0: Zero stuffing off 1: Zero stuffing on	0
02 General Mode Control	7	Data Format	0: Signed binary 1: Unsigned binary	0
	6	One Port Mode	0: Both input data ports receive data 1: Data port 1 only receives data	0
	5	Real Mode	0: Enable Q path for signal processing 1: Disable Q path data (clocks disabled)	0
	3	Inverse Sinc Enable	0: Inverse sinc disabled 1: Inverse sinc disabled	0
	2	DATACLK Invert	0: Output DATACLK same phase as internal capture clock 1: Output DATACLK opposite phase as internal capture clock	0
	1	IQ Select Invert	0: TxEnable (pin 39) =1, routes input data to I channel TxEnable (pin 39) =0, routes input data to Q channel 1: TxEnable (pin 39) =1, routes input data to Q channel TxEnable (pin 39) =0, routes input data to I channel	0
	0	Q First	0: First byte of data is always I data at beginning of transmit 1: First byte of data is always Q data at beginning of transmit	
03 Data Clock Delay	7:6	Data Delay Mode	00: Manual, no error correction 01: Manual, continuous error correction 10: automatic, one pass check 11: automatic, continuous pass check	00
	5:3	Data Clock Delay	Data Clock delay control	000
	2:0	Data Window Delay	Window delay control	000
04 Synchronization Delay	7:4	Sync Output Delay		0000
	3:0	Sync Window Delay		0000
05 Chip Sync and Data Delay Control	7	Sync Enable	0: LVDS and synchronization receiver logic off 1: LVDS and synchronization receiver logic on	0
	6	Sync Driver Enable	0: LVDS driver off 1: LVDS driver on	0
	5:3	DAC Clock Offset		0

Preliminary Technical Data

AD9776

06 IRQ Status	7	Data Delay Error (read only)		0
	6	Chip Synchronization Delay Error (read only)		0
	5	Cross Control Error (read only)		0
	3	Data Delay Error Enable		0
	2	Chip Synchronization Error Enable		0
	1	Cross Control Error Enable		0
07 PLL Band and Divide	7:3	PLL Band Select See Table 14 for values.		11001
	2:0	PLL Ripple Cap Adjust		111
08 PLL Enable and Charge Pump Control	7	PLL Enable	0: PLL off, DAC rate clock supplied by outside source 1: PLL on, DAC rate clock synthesized internally from data rate clock via PLL clock multiplier	0
	6:5	PLL Output Divide Ratio	00: Divide by 1 01: Divide by 2 10: Divide by 4 11: Divide by 8	01
	4:3	PLL Loop Feedback Divide Ratio	00: Divide by 1 01: Divide by 2 10: Divide by 4 11: Divide by 8	10
	2:0	PLL Loop Filter Bandwidth Tuning Recommended Settings. See Table 14 for PLL Band Select values.	000: PLL band select 00000-00111 100: PLL band select 01000-01111 110: PLL band select 10000-10111 111: PLL band select 11000-11111	111
09 Misc. Control	7	PLL Error Bit Source	0: Phase error detect 1: Range limit	0
	6	PLL Reference Bypass	0: Use PLL reference 1: Use DAC reference	0
	5:3	VCO AGC Gain Control. See Table 14 for PLL Band Select values.	000: PLL band select 00000-00111 100: PLL band select 01000-01111 110: PLL band select 10000-10111 111: PLL band select 11000-11111	111
	2:0	PLL Bias Current Level/Trim		000
0A IDAC Gain	7:0	IDAC Gain Adjustment	(7:0) LSB slice of 10 bit gain setting word for IDAC	11111001
0B IDAC Gain and Control	7	IDAC Sleep	0: IDAC on 1: IDAC off	0
	6	IDAC Power Down	0: IDAC on 1: IDAC off	0
	1:0	IDAC Gain Adjustment	(9:8) MSB slice of 10 bit gain setting word for IDAC	01
0C Auxiliary DAC1 Gain	7:0	Aux DAC1 Gain Adjustment	(7:0) LSB slice of 10 bit gain setting word for Aux DAC1	00000000

0D Auxiliary DAC1 Control and Data	7	Aux DAC1 Sign	0: Positive 1: Negative	0
	6	Aux DAC1 Direction	0: Source 1: Sink	0
	5	Aux DAC1 Sleep	0: Aux DAC1 on 1: Aux DAC 1 off	0
	1:0	Aux DAC1 Gain Adjustment	(9:8) MSB slice of 10 bit gain setting word for Aux DAC1	00
0E QDAC Gain	7:0	QDAC Gain Adjustment	(7:0) LSB slice of 10 bit gain setting word for QDAC	11111001
0F QDAC Gain and Control	7	QDAC Sleep	0: QDAC on 1: QDAC off	0
	6	QDAC Power Down	0: QDAC on 1: QDAC off	0
	1:0	QDAC Gain Adjustment	(9:8) MSB slice of 10 bit gain setting word for QDAC	01
10 Auxiliary DAC2 Gain	7:0	Aux DAC2 Gain Adjustment	(7:0) LSB slice of 10 bit gain setting word for Aux DAC2	00000000
11 Auxiliary DAC2 Control and Data	7	Aux DAC2 Sign	0: Positive 1: Negative	0
	6	Aux DAC2 Direction	0: Source 1: Sink	0
	5	Aux DAC2 Sleep	0: Aux DAC1 on 1: Aux DAC 1 off	0
	1:0	Aux DAC2 Gain Adjustment	(9:8) MSB slice of 10 bit gain setting word for Aux DAC2	00
12 Cross Point Upper Delay	7:0	Updelay	Value above zero for upper cross delay (bits 7,6, unused)	00000000
13 Cross Point Upper Delay	7:0	Dndelay	Value below zero for lower cross delay (bits 7,6, unused)	00000000
14 Wiggle Delay for Cross Point Control	7:3	Cross Control Clock Delay	Divide rate of CNTCLK by 2 ^{^(3:0)} , CNTCLK = 1/16 DAC clock rate	00000
	2:0	Wiggle Delay	Time step in 2 ^{^(Wiggle Delay)} CNTCLK cycles	000
15 Cross Point Control	7	Cross Run	0: Disables Cross Control loop 1: Enables Cross Control loop	0
	6	Cross Status (read only)	0: Control loop is lowering cross point 1: Control loop is raising cross point	0
	5	Cross Done (read only)	0: Control loop is chnaging cross point value 1: Control loop is holding cross point value	0
	4:2	Cross Wiggle	(2:0) Number of iterations allowed in control loop	000
	1:0	Cross Step	(1:0) Value to change cross point value per iteration (wiggle)	00
16 Analog Write	7:0	Analog Write	Provides extra writeable control registers for analog circuit	00000000
17 Mirror Roll off and band gap Trim	7:6	Mirror Roll off Frequency		00
	2:0	Band Gap Trim Temperature Characteristic		000
18 Output Stack headroom Control			Output stack headroom control	
			Overdrive (current density) trim (temperature packing)	
			Reference offset from VDD3V (vcas centering)	
19 Analog Status	7:0	Analog Status	Provides extra status register for analog circuitry (unused, read only)	

1A MISR Control	7	MISR Enable	0: MISR disabled 1: MISR Enabled	0
	6	MISR IQ Select	0: Read back I path signature 1: Read back Q path signature	0
	5	MISR Samples	0: MISR uses short sample period 1: MISR uses long sample period	0
	3	Internal Data Enable	0: Internal data generator off 1: Internal data generator on	0
	2:0	Test Mode	000: Normal data port operation 001-111: To be defined test modes	000
1B MISR Signature Register 1	7:0	MISR Signature	(31:24) Slice of 32 bit MISR signature	
1C MISR Signature Register 2	7:0	MISR Signature	(23:16) Slice of 32 bit MISR signature	
1D MISR Signature Register 3	7:0	MISR Signature	(15:8) Slice of 32 bit MISR signature	
1E MISR Signature Register 4	7:0	MISR Signature	(7:0) Slice of 32 bit MISR signature	

Table 12: SPI Register Description

Interp. Factor <7:6>	Filter Mode <5:2>	Filter1 mode (Mode_F1)	Filter2 mode (Mode_F2)	Filter3 mode (Mode_F3)	Modulation	Nyquist Zone Passband	F_low	Center	F_High		
							(Freq. Normalized to F _{DAC})				
8	00h	0	0	0	DC_odd	1	-0.05	0	0.05	In 8x interpolation, BW=0.0375-(0.1* F _{DAC}) Worst case: F/32	
8	01h	1	1	0	DC_even	2	0.0125	0.0625	0.1125		
8	02h	2	2	1	F/8_odd	3	0.075	0.125	0.175		
8	03h	3	3	2	F/8_even	4	0.1375	0.1875	0.2375		
8	04h	0	4	2	2F/8_odd	5	0.2	0.25	0.3		
8	05h	1	5	2	2F/8_even	6	0.2625	0.3125	0.3625		
8	06h	2	6	3	3F/8_odd	7	0.325	0.375	0.425		
8	07h	3	7	4	3F/8_even	8	0.3875	0.4375	0.4875		
8	08h	0	0	4	-4F/8_even	-8	0.45	0.5	0.55		
8	09h	1	1	4	-4F/8_odd	-7	0.5125	0.5625	0.6125		
8	0Ah	2	2	5	-3F/8_even	-6	0.575	0.625	0.675		
8	0Bh	3	3	6	-3F/8_odd	-5	0.6375	0.6875	0.7375		
8	0Ch	0	4	6	-2F/8_even	-4	0.7	0.75	0.8		
8	0Dh	1	5	6	-2F/8_odd	-3	0.7625	0.8125	0.8625		
8	0Eh	2	6	7	-F/8_even	-2	0.825	0.875	0.925		
8	0Fh	3	7	0	-F/8_odd	-1	0.8875	0.9375	0.9875		
4	00h	0	0	OFF	DC_odd	1	-0.1	0	0.1		In 8x interpolation, BW=0.075-(0.2* F _{DAC}) Worst case: F/16
4	01h	1	1	OFF	DC_even	2	0.025	0.125	0.225		
4	02h	2	2	OFF	F/4_odd	3	0.15	0.25	0.35		
4	03h	3	3	OFF	F/4_even	4	0.275	0.375	0.475		
4	04h	0	4	OFF	-F/2_even	-4	0.4	0.5	0.6		
4	05h	1	5	OFF	-F/2_odd	-3	0.525	0.625	0.725		
4	06h	2	6	OFF	-F/4_even	-2	0.65	0.75	0.85		
4	07h	3	7	OFF	-F/4_odd	-1	0.775	0.875	0.975		
2	00h	0	OFF	OFF	DC_odd	1	-0.2	0	0.2	In 2x Interpolation BW=0.15-0.4 F _{DAC} Worst case: F/8	
2	01h	1	OFF	OFF	DC_even	2	0.05	0.25	0.45		
2	02h	2	OFF	OFF	-F/2_even	-1	0.3	0.5	0.7		
2	03h	3	OFF	OFF	-F/2_odd	-2	0.55	0.75	0.95		

Table 13: Interpolation Filter Modes, see Reg 01, bits 5:2

PLL Frequency Band Select	
PLL Band Select Value	Frequency in MHz
11111 (31)	804 – 850
11110 (30)	827 – 875
11101 (29)	850 – 899
11100 (28)	875 – 925
11011 (27)	899 – 951
11010 (26)	925 – 977
11001 (25)	951 – 1005
11000 (24)	977 – 1032
10111 (23)	1004 – 1061
10110 (22)	1032 – 1089
10101 (21)	1060 – 1119
10100 (20)	1089 – 1149
10011 (19)	1118 – 1179
10010 (18)	1148 – 1210
10001 (17)	1176 – 1239
10000 (16)	1206 – 1270
01111 (15)	1237 – 1302
01110 (14)	1268 – 1334
01101 (13)	1299 – 1366
01100 (12)	1331 – 1399
01011 (11)	1363 – 1432
01010 (10)	1396 – 1466
01001 (9)	1425 – 1495
01000 (8)	1458 – 1529
00111 (7)	1492 – 1563

00110 (6)	1525 – 1597
00101 (5)	1560 – 1632
00100 (4)	1594 – 1667
00011 (3)	1629 – 1702
00010 (2)	1665 – 1737
00001 (1)	1700 – 1773
00000 (0)	1735 – 1810

Table 14. VCO Frequency Range vs. PLL Band Select Value

Internal Reference/Full Scale Current Generation

Full scale current on the AD9776 IDAC and QDAC can be set from 10 to 30ma. Initially, the 1.2V bandgap reference is used to set up a current in an external resistor connected to I120 (pin 75). A simplified block diagram of the AD9776 reference circuitry is given below in *Figure 29*. The recommended value for the external resistor is 10K Ω , which sets up an $I_{REFERENCE}$ in the resistor of 120 μ a. Internal current mirrors provide a current gain scaling, where IDAC or QDAC gain is a 10 bit word in the SPI port register (registers 0A, 0B, 0E, and 0F). The default value for the DAC gain registers gives an I_{FS} of 20ma.

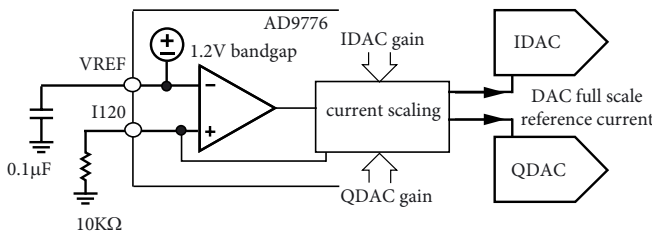

Figure 29. Reference Circuitry

where I_{FS} is equal to;

$$\frac{1.2V}{R} \times \left(\frac{27}{12} + \left(\frac{6}{1024} \times \text{DAC gain} \right) \right) \times 32$$

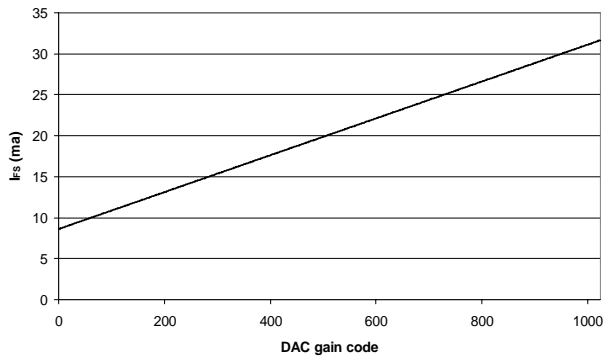

Figure 30. I_{FS} vs. DAC Gain Code

Auxiliary DACs

Two auxiliary DACs are provided on the AD9776. The full scale output current on these DACs is derived from the 1.2V bandgap reference and external resistor. The gain scale from the reference amplifier to the DAC reference current for each aux DAC is 16.67. with the Aux DAC gain set to full scale (10 bit values, SPI reg 0C, 0D, 10, 11), this gives a full scale current of 2ma for Aux DAC1 and for Aux DAC2. Through these same SPI port registers, the Aux DACs can be turned off, their signs can be inverted (scale is reversed, 0-1024 gives I_{FS} to 0), and they can be programmed for sourcing or sinking current. When sourcing current, the output compliance voltage is 0-1.5V, and when sinking current the output compliance voltage is 0.8-1.5V.

The Aux DACs can be used for LO cancellation when the DAC output is followed by a quadrature. A typical DAC to Quadrature Modulator interface is given in *Figure 31*. Often, the input common mode voltage for the modulator is much higher than the output compliance range of the DAC, so that ac coupling is necessary. The input referred offset voltage of these quadrature modulator can result in LO feed through on the modulator output, degrading system, performance. If the configuration of *Figure 29* is used, the Aux DACs can be used to compensate for the input DC offset of the quad mod, thus reducing LO feedthrough.

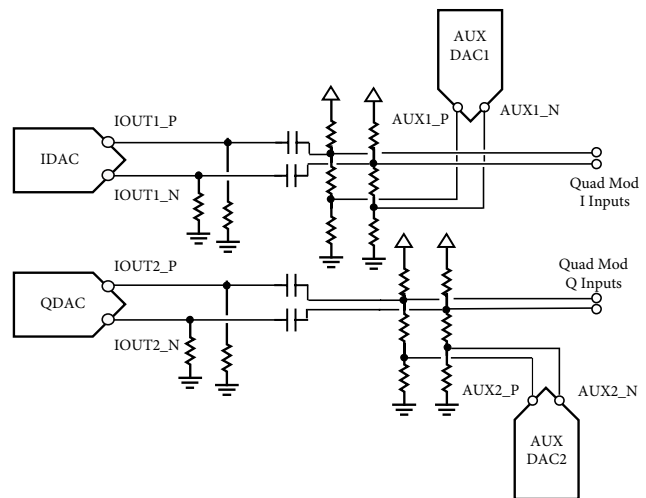

Figure 31. Typical Use of Auxiliary DACs

Power Down and Sleep Modes

The AD9776 has a variety of power down modes, so that the digital engine, main TxDACs, or auxiliary DACs can be powered down individually, or all at once. Via the SPI port, the main TxDACs can be placed in sleep or powered down modes. In sleep mode, the TxDAC output is turned off, thus reducing power dissipation. The reference remains powered on though, so that recovery from sleep mode is very fast. When the TxDAC is placed in Power Down mode, the TxDAC and 1.2V bandgap reference are turned off. This mode offers more substantial power savings than in sleep mode, but the time to turn on is much longer. The Auxiliary DACs also have the capability to be programmed via the SPI port into sleep mode.

The power down bit (register 00h, bit 4) controls the power down function for the digital section of the AD9776. The power down function in bit 4 in conjunction with TxEnable (pin 39) according to the following;

TxEnable =

0:PWDWN=

0: Flush data path with zeroes

1: Digital engine in power down state, DACs and reference are not affected.

1: Normal operation

Internal PLL Clock Multiplier / Clock Distribution

The internal clock structure on the AD9776 allows the user to drive the differential clock inputs with a clock at 1x or an integer multiple of the input data rate, or at the DAC output sample rate. A PLL internal to the AD9776 provides input clock multiplication and provides all of the internal clocks required for the interpolation filters and data synchronization.

The internal clock architecture is shown in Figure 32. The reference clock is the differential clock at pins 5 and 6. This clock input can be run differentially, or singled ended by driving pin 5 with a clock signal, and biasing pin 6 to the mid swing point of the signal at pin 5. There are various configurations in which this clock architecture can be run;

1. PLL Enabled (reg 08h, bit 7=1) – The PLL enable switch in Figure 32 is connected to the junction of the dividers N1 and N2. Divider N3 determines the interpolation rate of the DAC, and the ratio N2/N3 determines the ratio of Reference Clock/Input Data Rate. The VCO runs optimally over the range 804MHz to 1800MHz, so that N1 is used to keep the speed of the VCO in this range, even though the DAC sample rate may be lower. The loop filter components are entirely internal and no external compensation is necessary.

2. PLL Disabled (reg 08h, bit 7=0) – The PLL enable switch in Figure 32 is connected to the Reference Clock Input. The differential reference clock input will be the DAC output sample rate and N3 will determine the interpolation rate.

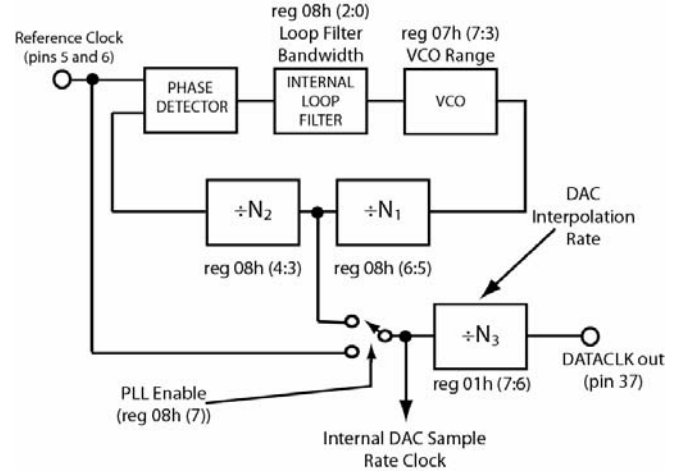

Figure 32. Internal Clock Architecture of AD9776

Timing Information

Figure 33 through Figure 35 show some of the various timing possibilities when the PLL is enabled. The combination of the settings of N2 and N3 means that the reference clock frequency may be a multiple of the actual input data rate. Figure 33 through Figure 35 show, respectively, what the timing looks like when N2/N3 = 1, 2, and 4.

Figure 36 shows the timing specifications for the AD9776 when the PLL is disabled. The reference clock is at the DAC output sample rate. In the example shown in Figure 36, if the PLL is disabled, the interpolation is 4x.. The set up and hold time for the input data are with respect to the rising edge of the reference clock which occurs just before the rising edge of the DATACLK out. Note that if reg 02h, bit2 is set, DATACLK out is inverted so the latching reference clock edge will occur just before the DATACLK out falling edge.

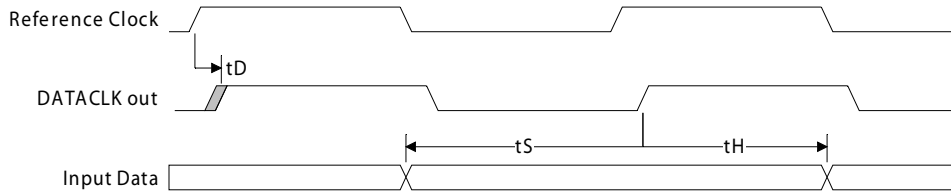

Figure 33. Timing Specifications for AD9776, PLL Enabled, Reference Clock = 1x Input Sample Rate

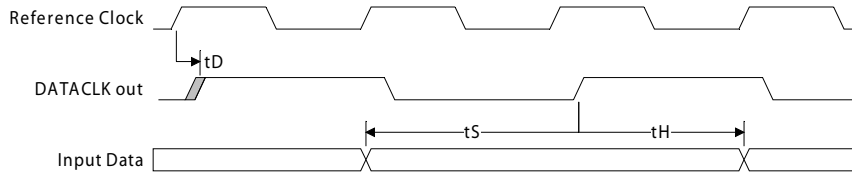

Figure 34. Timing Specifications for AD9776, PLL Enabled, Reference Clock = 2x Input Sample Rate

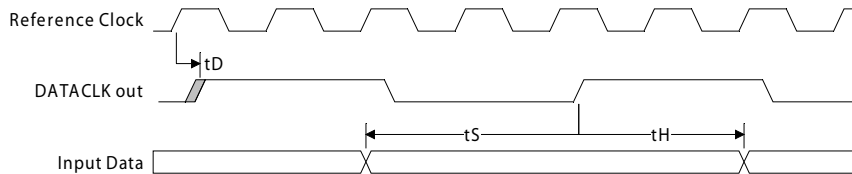
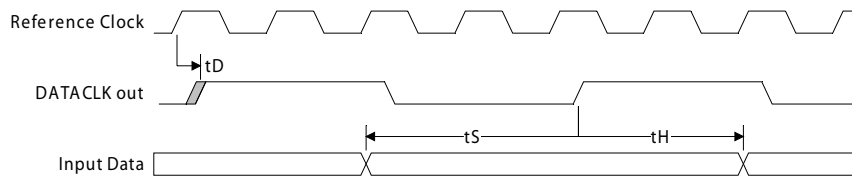

Figure 35. Timing Specifications for AD9776, PLL Enabled, Reference Clock = 4x Input Sample Rate



tS=2.3ns typ
tH=3.7ns typ
tD=5.5ns typ

Figure 36. Timing Specifications for AD9776, PLL Disabled, 4x Interpolation

Using Data Delay to Meet Timing Requirements

In order to meet strict timing requirements at input data rates of up to 250MSPS, the AD9776 has a fine timing feature. Fine timing adjustments can be made by programming values into the DATA CLOCK DELAY register (reg 03h, 5:3). By changing the values in this register, delay can be added to the default delay between the DACCLK in the DATACLK in the DATACLK out. The effect of this is shown in Figure 37 and Figure 38.

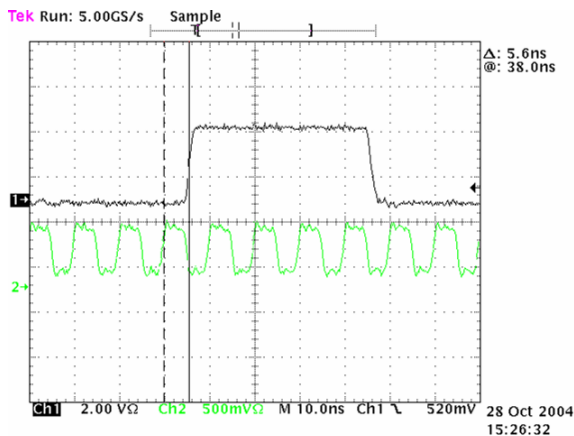

Figure 37. Delay from DACCLK to DATACLK out with CLK DATA DELAY = 000

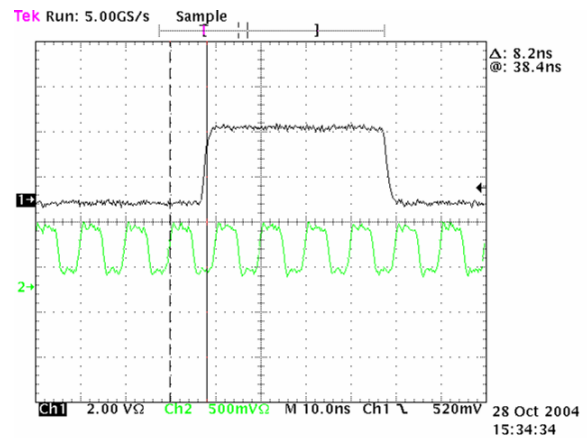

Figure 38. Delay from DACCLK to DATACLK out with CLK DATA DELAY = 111

The difference between the default delay of Figure 37 and the maximum delay shown in Figure 38 is the range programmable via the DATA CLK DELAY register. The resulting delays when programming DATA CLK DELAY between 000 and 111 are a linear extrapolation between these two figures. (typically 300ps-400ps per increment to DATA CLK DELAY).

Interpolation Filter Architecture

The AD9776 can provide up to 8× interpolation or disable the interpolation filters entirely. The coefficients of the low pass filters and the inverse sinc filter are given in Table 5, Table 6, Table 7, and Table 8. Spectral plots for the filter responses are given in Figure 3, Figure 4, and Figure 5.

With the interpolation filter and modulator combined, the incoming signal can be placed anywhere within the Nyquist region of the DAC output sample rate. Where the input signal is complex, this architecture allows modulation of the input signal to positive or negative Nyquist regions (refer to Table 13).

The Nyquist regions up to 4× the input data rate can be seen in Figure 39.

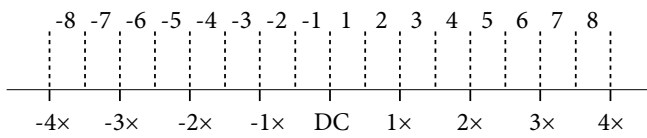

Figure 39. Nyquist Zones

Figure 3, Figure 4 and Figure 5 show the low pass response of the digital filters with no modulation used. By turning on the modulation feature, the response of the digital filters can be tuned to any Nyquist zone within the DAC bandwidth. As an example, Figure 40 to Figure 46 show the odd mode filter responses (refer to Table 13 for odd/even mode filter responses).

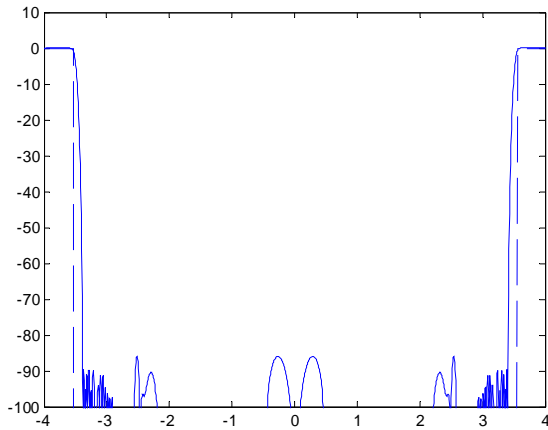

Figure 40. Interpolation/Modulation Combination of $-4f_{DAC}/8$ Filter in Odd Mode

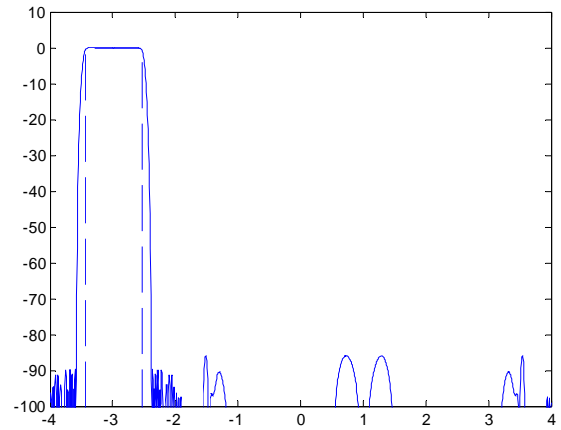

Figure 41. Interpolation/Modulation Combination of $-3f_{DAC}/8$ Filter in Odd Mode

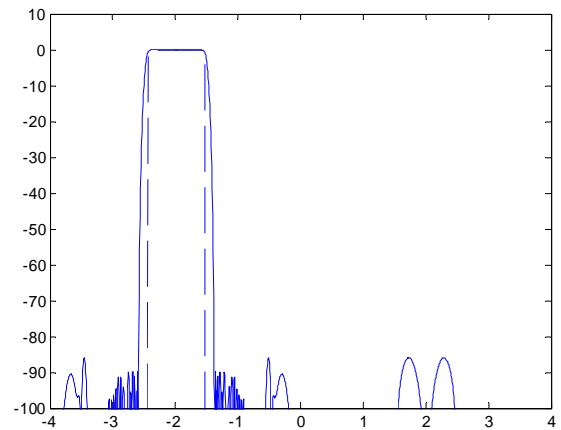

Figure 42. Interpolation/Modulation Combination of $-2f_{DAC}/8$ Filter in Odd Mode

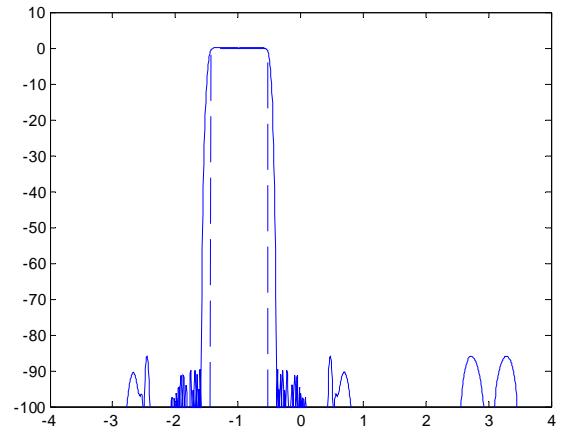

Figure 43. Interpolation/Modulation Combination of $-1f_{DAC}/8$ Filter in Odd Mode

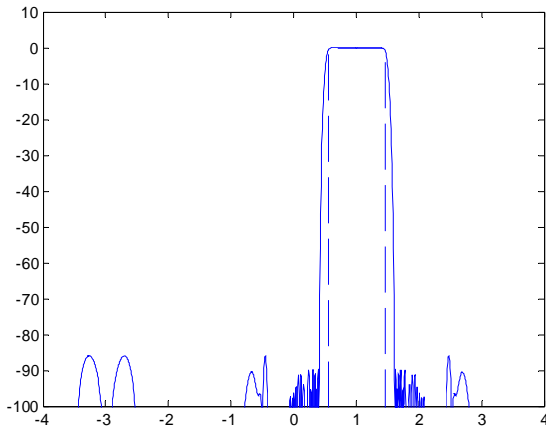

Figure 44. Interpolation/Modulation Combination of $f_{DAC}/8$ Filter in Odd Mode

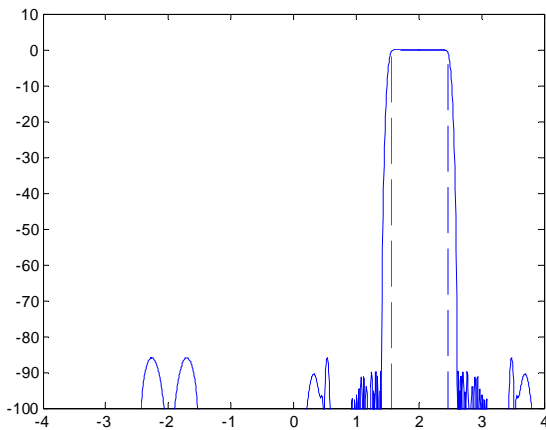

Figure 45. Interpolation/Modulation Combination of $2f_{DAC}/8$ Filter in Odd Mode

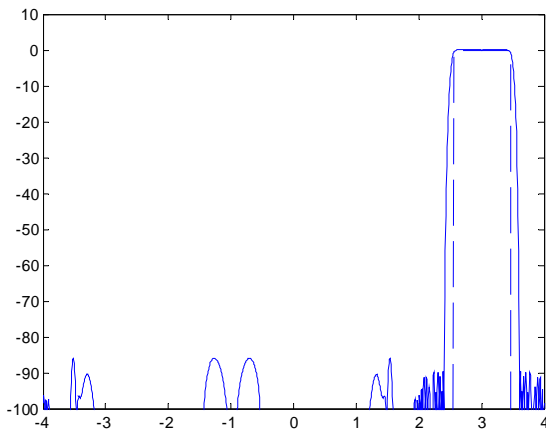

Figure 46. Interpolation/Modulation Combination of $3f_{DAC}/8$ Filter in Odd Mode

Even mode filter responses allow the passband to be centered around ± 0.5 , ± 1.5 , ± 2.5 and $\pm 3.5 F_{DATA}$. Switching from an odd mode response to an even mode filter response does not modulate the signal. Instead, the pass band is simply shifted. As an example, picture the response of Figure 46, and assume the signal in band is a complex signal over the bandwidth 3.2 to $3.3 \times F_{DATA}$. If the even mode filter response is then selected, the pass band will now be centered at $3.5 \times F_{DATA}$. However, the signal will still remain at the same place in the spectrum. The even/odd mode capability allows the passband to be placed anywhere in the DAC Nyquist bandwidth.

The AD9776 is a dual DAC with an internal complex modulator built into the interpolating filter response. The modulator can be set to a real or a complex mode by programming register 02h, bit 5. In the default mode, bit 5 is set to zero and the modulation is complex. The AD9776 then expects the real and the imaginary components of a complex signal at digital input ports one and two (I and Q respectively). The DAC outputs will then represent the real and imaginary components of the input signal, modulated by the complex carrier $F_{DAC}/2$, $F_{DAC}/4$ or $F_{DAC}/8$.

With Bit 5 set to one, the modulation is real. The Q channel is shut off and its value at the modulator inputs replaced with zero. The output spectrum at either the IDAC or the QDAC will then represent the signal at digital input port one, real modulated by the internal digital carrier ($F_{DAC}/2$, $F_{DAC}/4$ or $F_{DAC}/8$).

EVALUATION BOARD SCHEMATICS

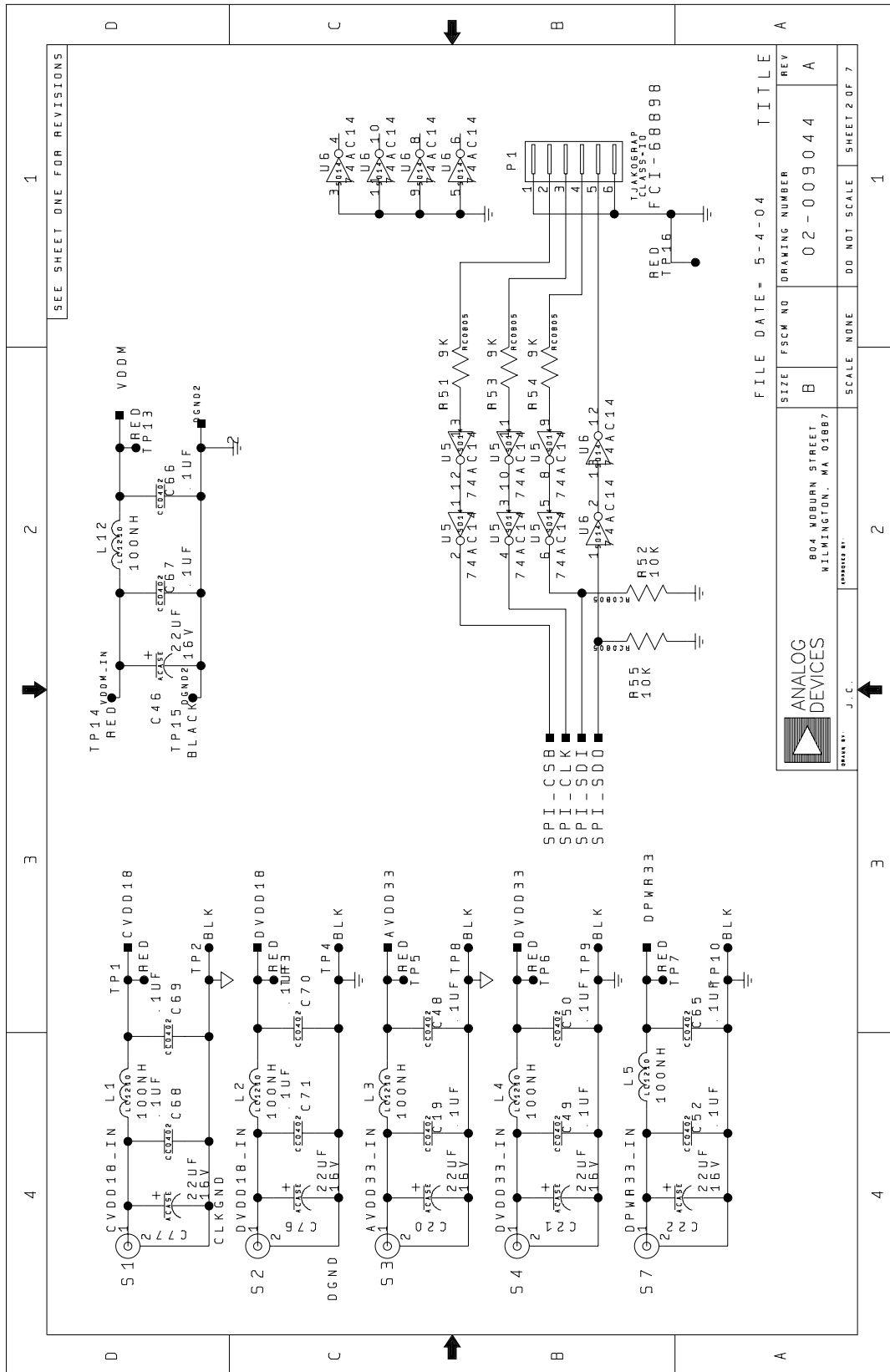

Figure 47. AD9776 Eval Board, Rev B, Power Supply Decoupling and SPI Interface

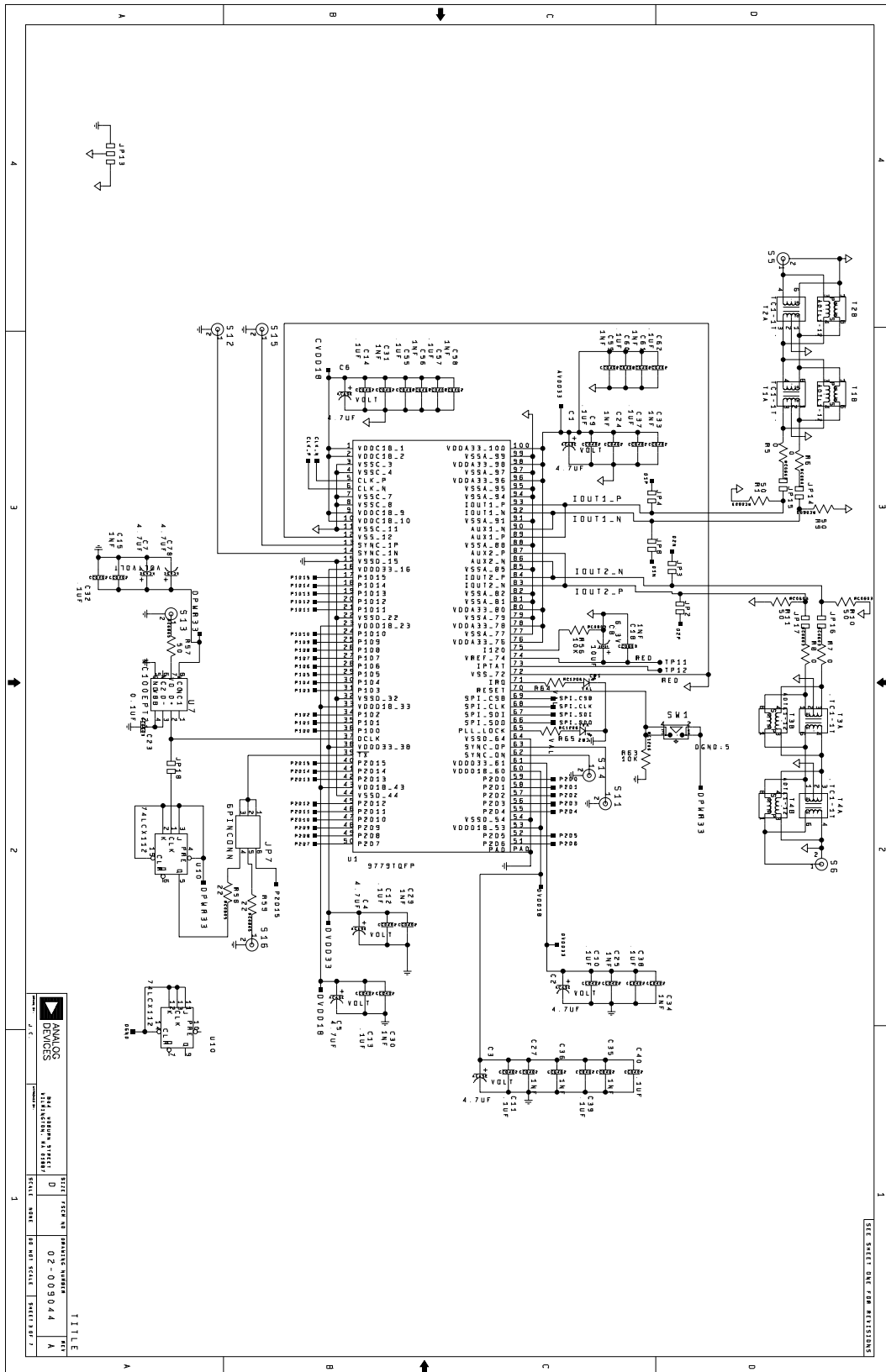

Figure 48. AD9776 Eval Board, Rev B, Circuitry Local to AD9776

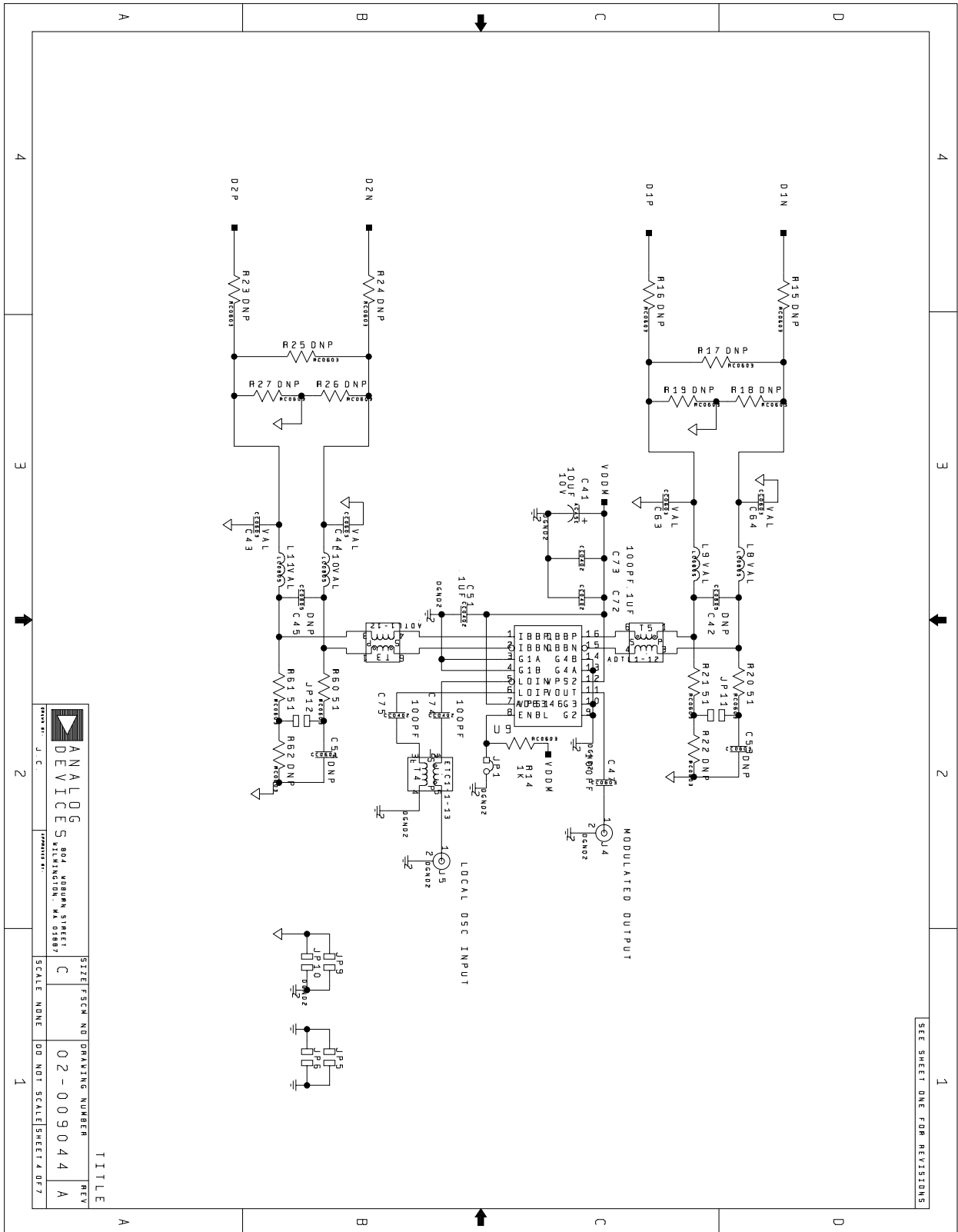

Figure 49. AD9776 Eval Board, RevB, AD8349 Quadrature Modulator

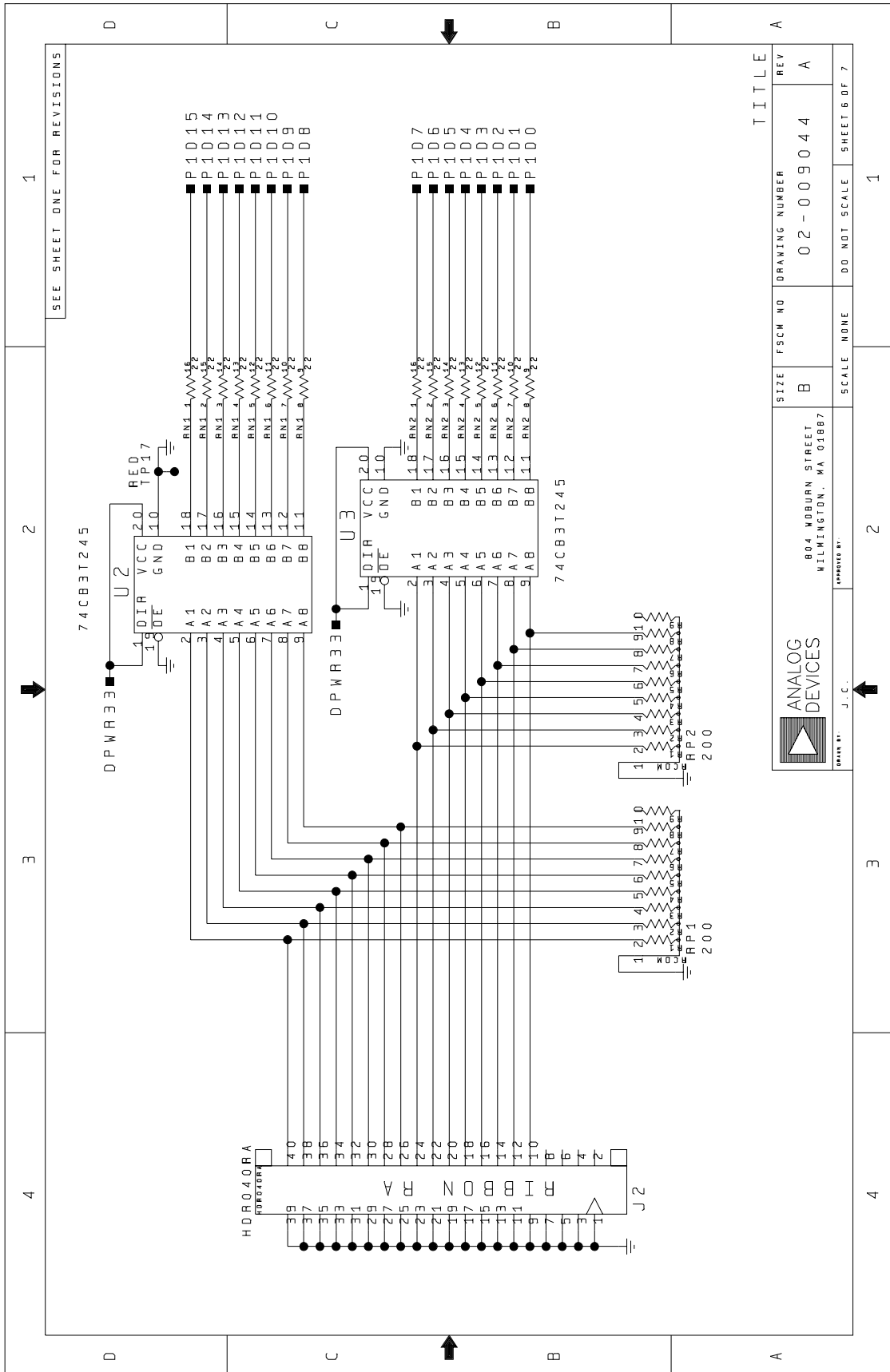
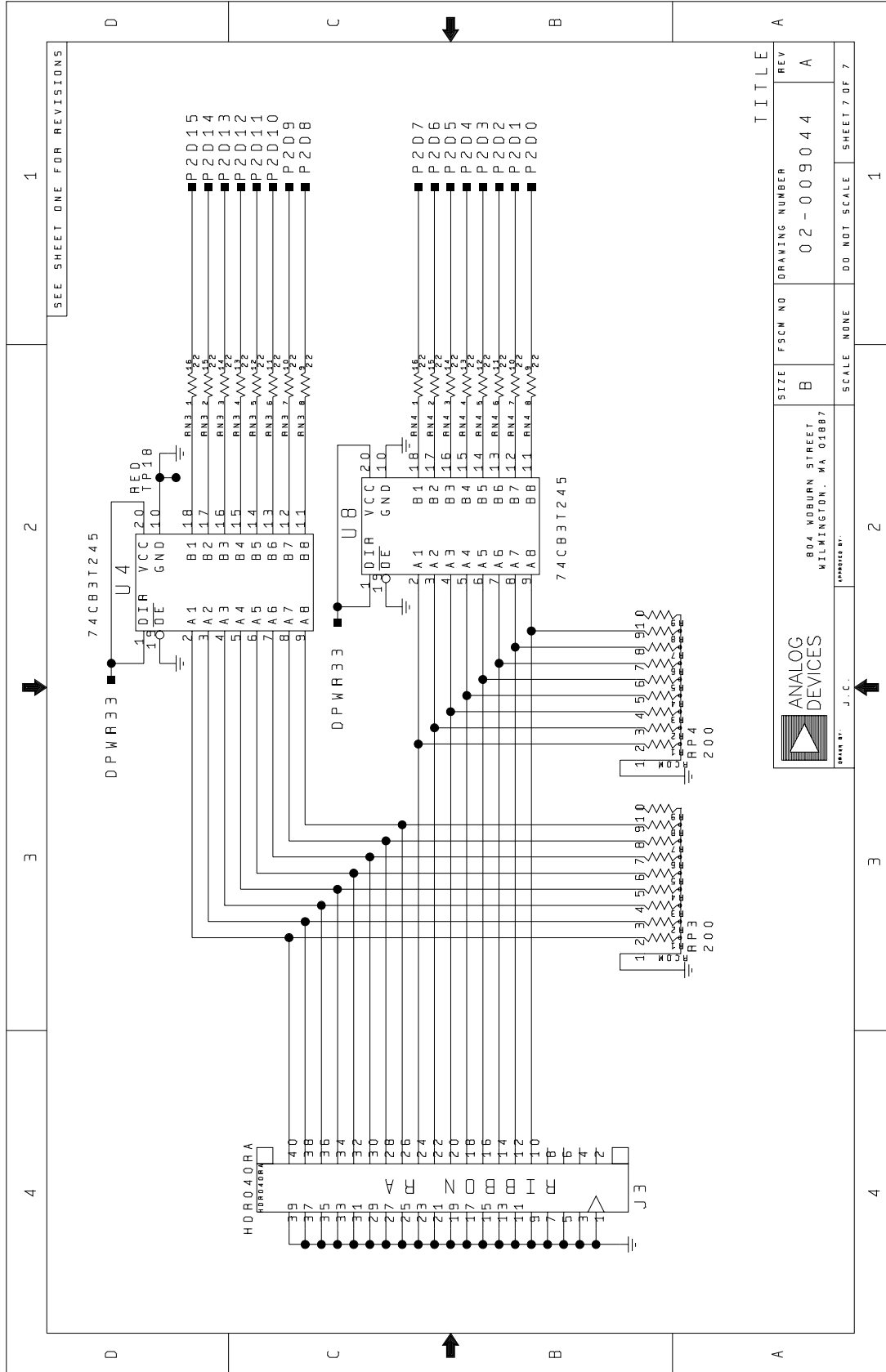

Figure 51. AD9776 Eval Board, RevB, Input Port 1, Digital Input Buffers



TITLE		SIZE	FSCM NO	DRAWING NUMBER	REV
ANALOG DEVICES 804 WOBURN STREET WILMINGTON, MA 01887		B		02-09044	A
		SCALE NONE		DO NOT SCALE	SHEET 7 OF 7

Figure 52. AD9776 Eval Board, RevB, Input Port 2, Digital Input Buffers

OUTLINE DIMENSIONS

TOP VIEW

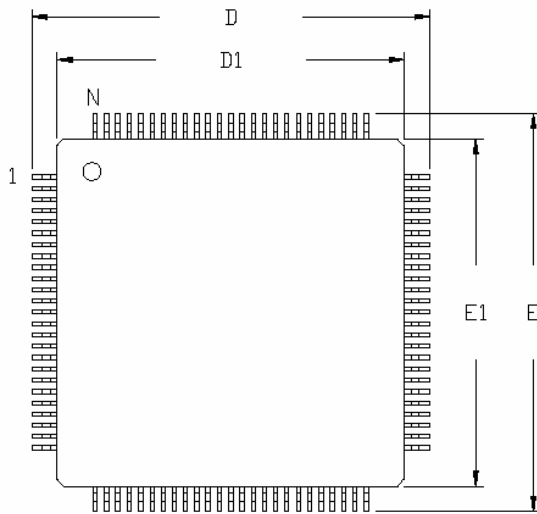

BOTTOM VIEW

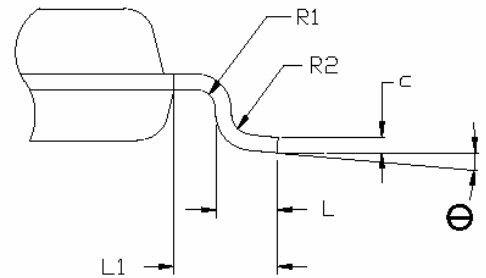
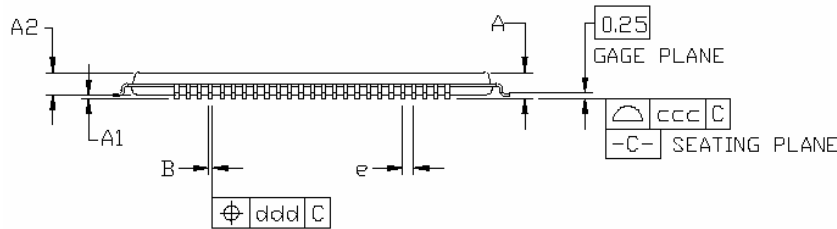
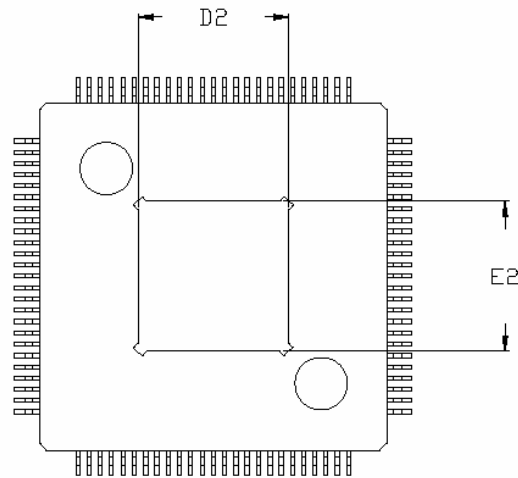

NOTES:

1. Controlling Dimensions are in mm.
2. All dimensions per JEDEC Standards MS-026-Variation.
3. Inverted Form is Paddle Up and Die Down

COMMON DIMENSIONS			
Dim	Min.	Nom.	Max
A			1.20
A1	0.05		0.15
A2	0.95	1.00	1.05
L	0.45	0.60	0.75
L1	1.00 REF		
θ	0°	3.5°	7°
R1	0.08		
R2	0.08		0.20
c	0.09		0.20

14X14X1.0(OPTION 2)				
N = 100 Leads				
Variation AED(see note 2)				
Dim	Min	Nom	Max	Note
e	0.50 BSC			
D2	9.5			
E2	9.5			
D	15.80	16.00	16.20	
D1	13.80	14.00	14.20	
E	15.80	16.00	16.20	
E1	13.80	14.00	14.20	
B	0.17	0.22	0.27	
ccc	0.08			
ddd	0.08			

ESD CAUTION

ESD (electrostatic discharge) sensitive device. Electrostatic charges as high as 4000 V readily accumulate on the human body and test equipment and can discharge without detection. Although this product features proprietary ESD protection circuitry, permanent damage may occur on devices subjected to high energy electrostatic discharges. Therefore, proper ESD precautions are recommended to avoid performance degradation or loss of functionality.



ORDERING GUIDE

Model	Temperature Range	Description
AD9776BSV	-40°C to +85°C (Ambient)	100-Lead TQFP, Exposed Paddle
AD9776/PCB	25°C (Ambient)	Evaluation Board